

HYGIENSKYDD

effektiv överallt

PROTECTION GLAZING

effective for any area



MADE
IN
GERMANY

Pauli Scandinavia AB
Member of Pauli + Sohn GmbH group





■ MADE
■ IN
■ GERMANY

Effektivt hygienskydd med flexibla system

effective hygiene protection with flexible systems

Hälsa är vår mest värdefulla tillgång. I tider med ökad risk för smitta måste företag ta till särskilda åtgärder, för att förhindra droppinfektioner bland anställda och i kundkontakt erbjuder Pauli + Sohn olika uppsättningar effektivt som nys- och hostskydd - till exempel för kunddiskar och mottagningsområden.

mobil eller som en stationär installation

De flexibla systemen för skydd mot droppinfektioner finns som mobila stativ eller stationära moduler - valfritt med glas eller akryl med olika storlekar och tjocklekar, med eller utan öppning och med olika utseenden. Systemen levereras antingen komplett som ett set inklusive glas/plast och tillbehör, eller enbart beslag. De olika systemen är enkla att montera och har en säker, funktionell och modern design. Produktion i Tyskland - med en hög standard av kvalitet och med en pålitlig leverans tillgänglighet. Lita på oss med säkerhet på arbetsplatsen!

Fördelar med detta system:

- monteringsystem för mobila och stationära installationer (inklusive beslag och panel)
- Komplet set för 1, 2 resp 3sektioner
- individuella designalternativ
- brett utbud av finish på beslag
- specifika utformningar på begäran
- tillverkad i Tyskland - högsta kvalitet, säkra leveranser

Health is the most valuable asset. In times of increased infection by viruses or flu pathogens, companies must take special protective measures. To prevent droplet infections among employees and in customer contact, Pauli + Sohn offers you various sets for hygienically effective sneeze and cough protection - for example for sales counters, reception areas and counters.

mobile or as a stationary installation

The flexible systems for protection against droplet infections are available as mobile stands or stationary modules - optionally with glass or acrylic glass, with variable pane sizes and thicknesses, with or without pass-through and with different surfaces. The systems are conveniently supplied as a set including a measurement sheet and accessories - from connectors, clamps and posts to corresponding screws. All systems are easy to assemble and also have a safe, functional and modern design. And made in Germany - manufactured to a high standard of quality and as a rule, reliably available. Place your trust in us with safety at the workplace!

advantages at a glance:

- mounting systems for free-standing and stationary installations (including accessories and measurement sheet)
- sets from 1 pane up to 3 panes
- individual design options
- wide range of colours for the hardware
- special designs on request
- made in Germany - short transport routes, reliable delivery

Set-3078: En sektion utan öppning | 1 panel without passthrough

MADE
IN
GERMANY

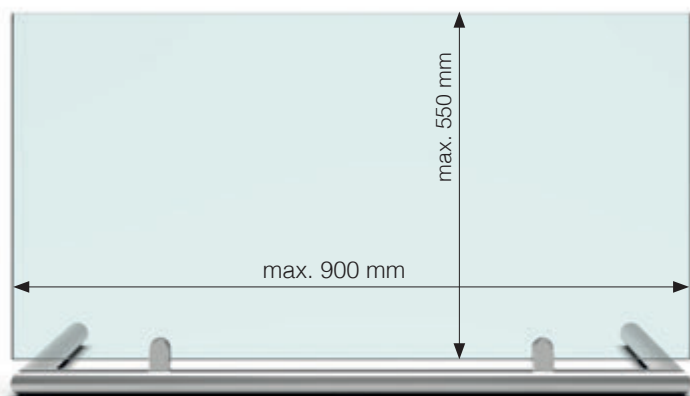

3030/3031

Artikel nr. article no	Glastjocklek glass thickness
Set-3078	4/6 mm*
Yta finish	
ZN12	Grålackad finish Aluminium look, powder coated
ZN22	RF Finish stainless steel optic
RAL	Specialfinish - valfri RAL all colors available on request

*Ange glastjocklek vid beställning! Glas kan levereras som tillval.
*Please specify glass thickness when ordering! Glass panel can be supplied optionally.

Rör i RF material | tubes are brushed stainless steel

Set-3079: En sektion med öppning | 1 panel with passthrough

MADE
IN
GERMANY

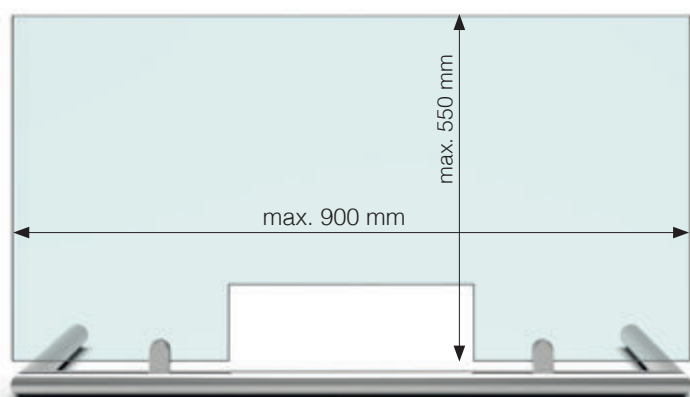

3030/3031

Artikel nr. article no	Glastjocklek glass thickness
Set-3079	4/6 mm*
Yta finish	
ZN12	Grålackad finish Aluminium look, powder coated
ZN22	RF Finish stainless steel optic
RAL	Specialfinish - valfri RAL all colors available on request

*Ange glastjocklek vid beställning! Glas kan levereras som tillval.
*Please specify glass thickness when ordering! Glass panel can be supplied optionally.

Rör i RF material | tubes are brushed stainless steel

Set-3077: En sektion utan öppning | 1 panel without pass-through

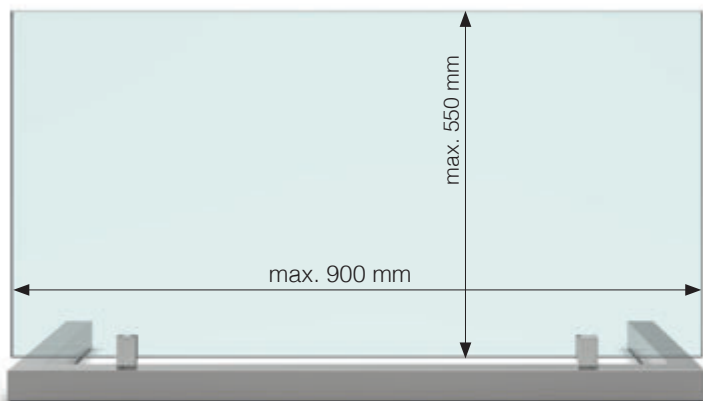

3000/3001

Artikel nr. article no	Glastjocklek glass thickness
Set-3077	4/6 mm*
Yta finish	
ZN12	Grålackad finish Aluminium look, powder coated
ZN22	RF Finish stainless steel optic
RAL	Specialfinish - valfri RAL all colors available on request

*Ange glastjocklek vid beställning! Glas kan levereras som tillval.
*Please specify glass thickness when ordering! Glass panel can be supplied optionally.

Rör i RF material | tubes are brushed stainless steel

Set-3076: En sektion med öppning | 1 panel with pass-through

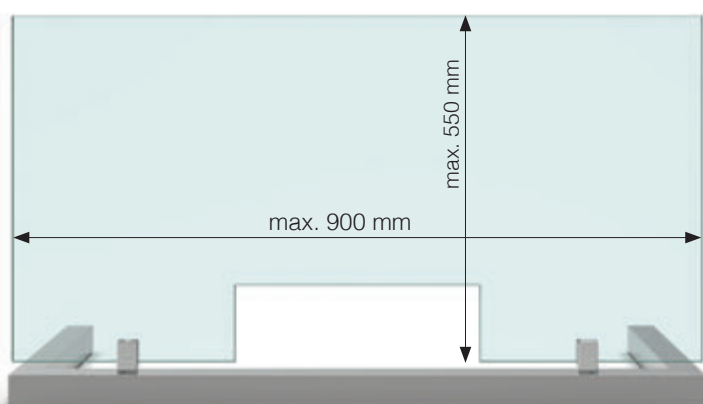

3000/3001

Artikel nr. article no	Glastjocklek glass thickness
Set-3076	4/6 mm*
Yta finish	
ZN12	Grålackad finish Aluminium look, powder coated
ZN22	RF Finish stainless steel optic
RAL	Specialfinish - valfri RAL all colors available on request

*Ange glastjocklek vid beställning! Glas kan levereras som tillval.
*Please specify glass thickness when ordering! Glass panel can be supplied optionally.

Rör i RF material | tubes are brushed stainless steel

Set-3087: En sektion utan öppning | 1 panel without pass-through

MADE
IN
GERMANY

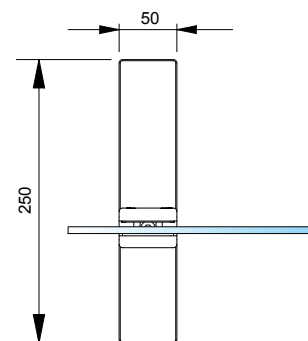
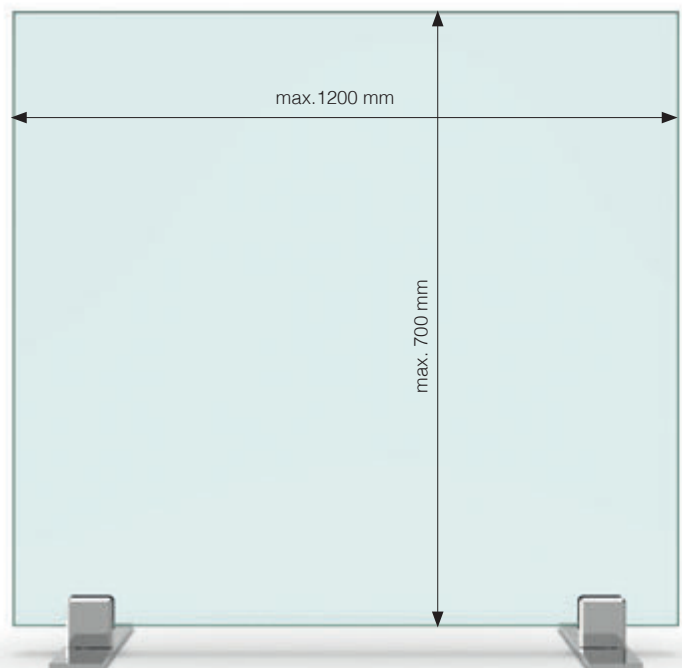

Artikel nr. article no	Glastjocklek glass thickness
Set-3087	6-12,76 mm*
Yta finish	
ZN12	Grålackad finish Aluminium look, powder coated
ZN22	RF Finish stainless steel optic
RAL	Specialfinish - valfri RAL all colors available on request
VA2	Rostfritt - mattborstat utseende stainless steel matt brushed

*Ange glastjocklek vid beställning! Glas kan levereras som tillval.
*Please specify glass thickness when ordering! Glass panel can be supplied optionally.

Platta i RF - mattborstat utseende | baseplate is brushed stainless steel

Set-3088: En sektion med öppning | 1 panel with pass-through

MADE
IN
GERMANY

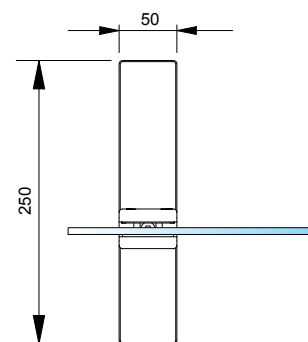
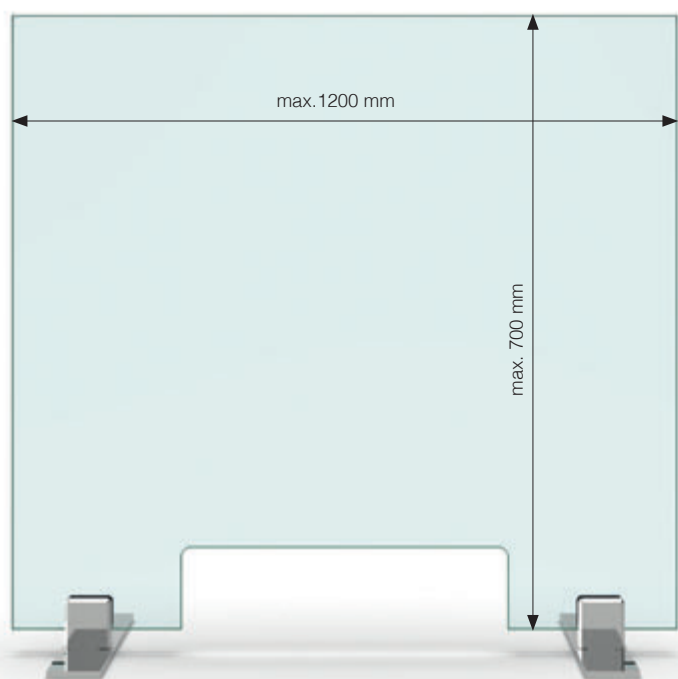

Artikel nr. article no	Glastjocklek glass thickness
Set-3088	6-12,76 mm*
Yta finish	
ZN12	Grålackad finish Aluminium look, powder coated
ZN22	RF Finish stainless steel optic
RAL	Specialfinish - valfri RAL all colors available on request
VA2	Rostfritt - mattborstat utseende stainless steel matt brushed

*Ange glastjocklek vid beställning! Glas kan levereras som tillval.
*Please specify glass thickness when ordering! Glass panel can be supplied optionally.

Platta i RF - mattborstat utseende | baseplate is brushed stainless steel

Set-3085: En sektion utan öppning | 1 panel without passthrough

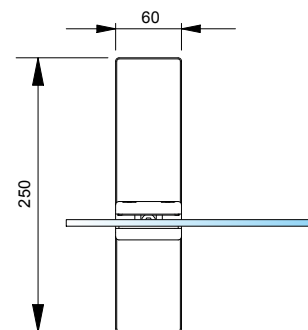
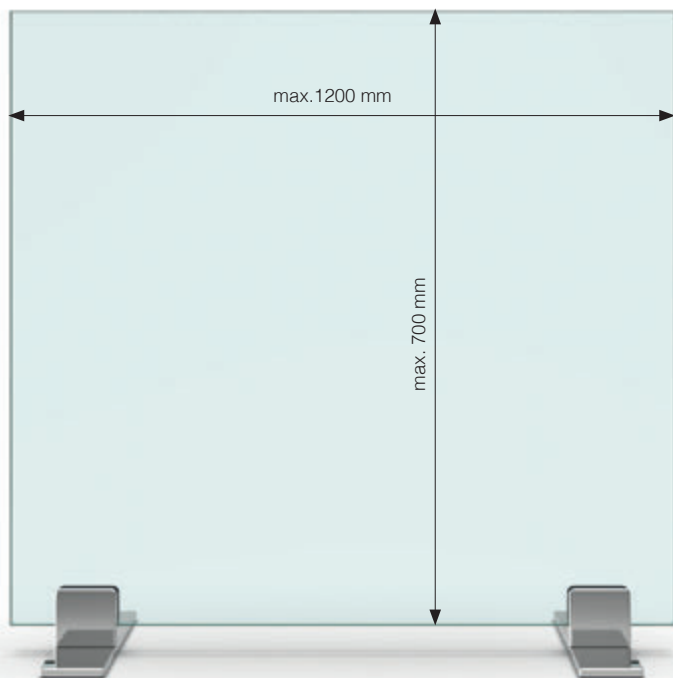

Artikel nr. article no	Glastjocklek glass thickness
Set-3085	6-12,76 mm*
Yta finish	
ZN12	Grålackad finish Aluminium look, powder coated
ZN22	RF Finish stainless steel optic
RAL	Specialfinish - valfri RAL all colors available on request
VA2	Rostfritt - mattborstat utseende stainless steel matt brushed

*Ange glastjocklek vid beställning! Glas kan levereras som tillval.
*Please specify glass thickness when ordering! Glass panel can be supplied optionally.

Platta i RF - mattborstat utseende | baseplate is brushed stainless steel

Set-3086: En sektion med öppning | 1 panel with passthrough

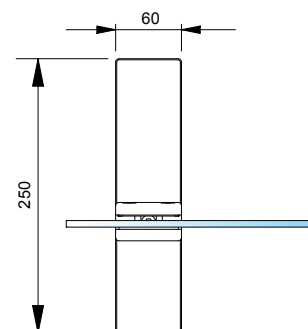
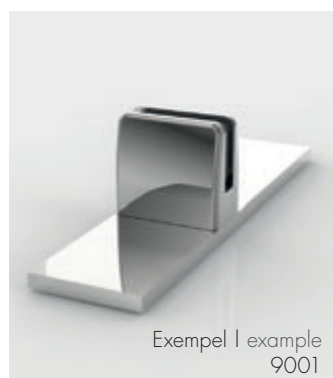
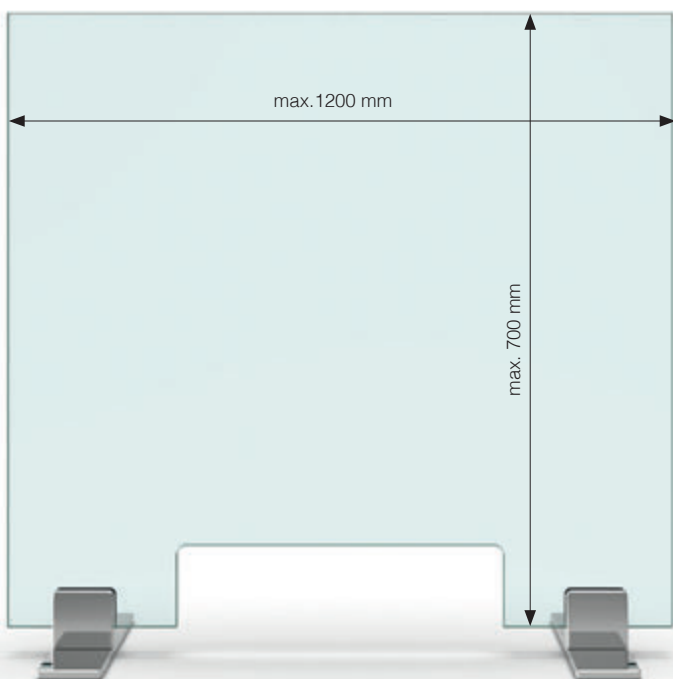

Artikel nr. article no	Glastjocklek glass thickness
Set-3086	6-12,76 mm*
Yta finish	
ZN12	Grålackad finish Aluminium look, powder coated
ZN22	RF Finish stainless steel optic
RAL	Specialfinish - valfri RAL all colors available on request
VA2	Rostfritt - mattborstat utseende stainless steel matt brushed

*Ange glastjocklek vid beställning! Glas kan levereras som tillval.
*Please specify glass thickness when ordering! Glass panel can be supplied optionally.

Platta i RF - mattborstat utseende | baseplate is brushed stainless steel

Set-3083: En sektion utan öppning | 1 panel without pass-through

MADE
IN
GERMANY

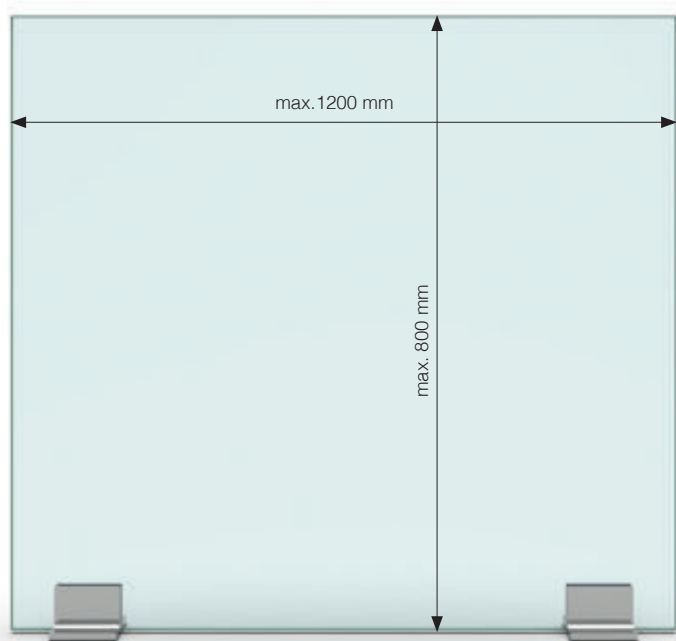

*Ange glastjocklek vid beställning! Glas kan levereras som tillval..
*Please specify glass thickness when ordering! Glass panel can be supplied optionally.

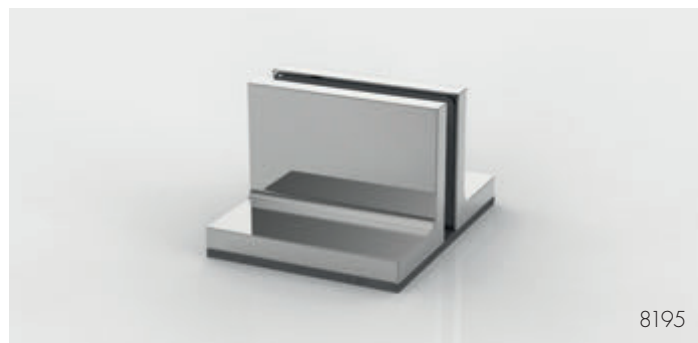

8195

Artikel nr. article no	Glastjocklek glass thickness
Set-3083	6/8/10 mm*
Yta finish	
ZN5	Blankrom gloss chrome
ZNPVD22	RF Finish stainless steel optic
ZN35	Svartlackad black
RAL	Specialfinish - valfri RAL all colors available on request

Set-3084: En sektion med öppning | 1 panel with pass-through

MADE
IN
GERMANY

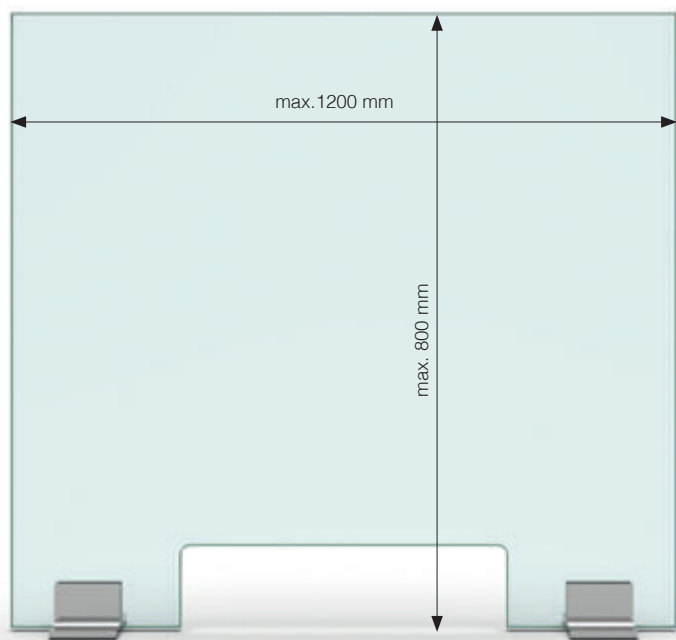

*Ange glastjocklek vid beställning! Glas kan levereras som tillval..
*Please specify glass thickness when ordering! Glass panel can be supplied optionally.

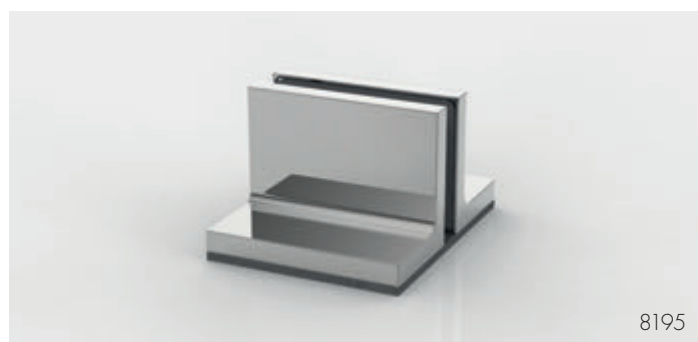

8195

Artikel nr. article no	Glastjocklek glass thickness
Set-3084	6/8/10 mm*
Yta finish	
ZN5	Blankrom gloss chrome
ZNPVD22	RF Finish stainless steel optic
ZN35	Svartlackad black
RAL	Specialfinish - valfri RAL all colors available on request



Set-3089: En sektion med öppning | 1 panel with passthrough

MADE
IN
GERMANY

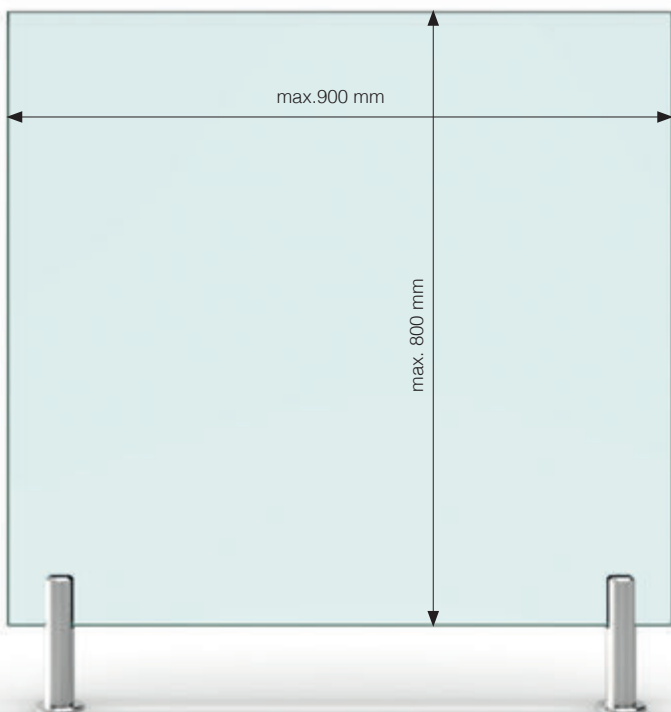

Artikel nr. article no	Glastjocklek glass thickness
Set-3089	8-12,76 mm*
Yta finish	
VA	Rostfritt stainless steel

*Ange glastjocklek vid beställning! Glas kan levereras som tillval.
*Please specify glass thickness when ordering! Glass panel can be supplied optionally.

Set-3074: En sektion utan öppning | 1 panel without pass-through

Tillgänglig sommar 2020
available in summer 2020

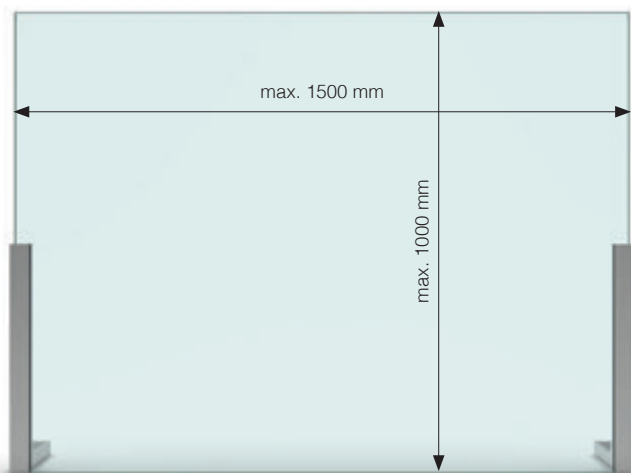

*Ange glastjocklek vid beställning! Glas kan levereras som tillval.
*Please specify glass thickness when ordering! Glass panel can be supplied optionally.



Artikel nr. article no	Glastjocklek glass thickness
Set-3074	6-10 mm*
Yta finish	
MS7	Blankkrom gloss chrome
MSPVD22	RF Finish stainless steel optic
MS35	Svartlackad matt black
RAL	Specialfinish - valfri RAL all colors available on request

Set-3090: En sektion med öppning | 1 panel with pass-through

Tillgänglig sommar 2020
available in summer 2020

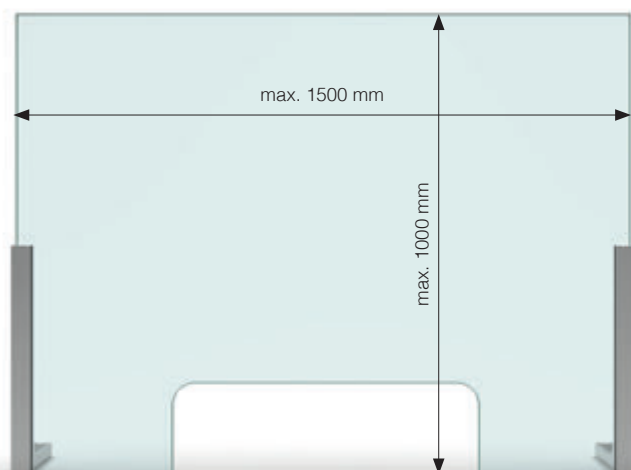

*Ange glastjocklek vid beställning! Glas kan levereras som tillval.
*Please specify glass thickness when ordering! Glass panel can be supplied optionally.



Artikel nr. article no	Glastjocklek glass thickness
Set-3090	6-10 mm*
Yta finish	
MS7	Blankkrom gloss chrome
MSPVD22	RF Finish stainless steel optic
MS35	Svartlackad black
RAL	Specialfinish - valfri RAL all colors available on request

Set-3063: En sektion utan öppning | 1 panel without passthrough

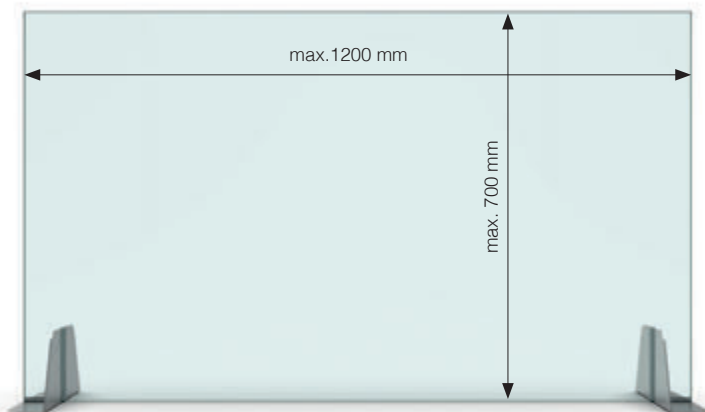

*Ange glastjocklek vid beställning! Glas kan levereras som tillval.
*Please specify glass thickness when ordering! Glass panel can be supplied optionally.

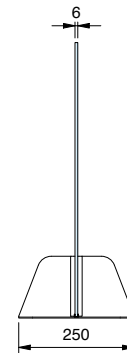

Artikel nr. article no	Glastjocklek glass thickness
Set-3063	6 mm*
Yta finish	
VA2	Rostfritt - mattborstat utseende stainless steel matt brushed

Set-3062: En sektion med öppning | 1 panel with passthrough

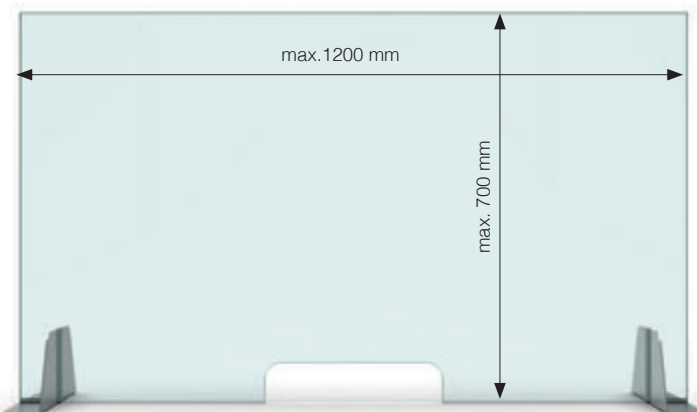

*Ange glastjocklek vid beställning! Glas kan levereras som tillval.
*Please specify glass thickness when ordering! Glass panel can be supplied optionally.

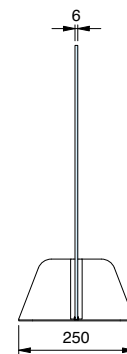

Artikel nr. article no	Glastjocklek glass thickness
Set-3062	6 mm*
Yta finish	
VA2	Rostfritt - mattborstat utseende stainless steel matt brushed

Set-3099: Två sektioner(90°) utan öppning | 2 panels (90°) without passthrough

MADE
IN
GERMANY



3030/3031

Artikel nr. article no	Glastjocklek glass thickness
Set-3099	4/6 mm*
Yta finish	
ZN12	Grålackad finish Aluminium look, powder coated
ZN22	RF Finish stainless steel optic
RAL	Specialfinish - valfri RAL all colors available on request

Rör i RF material | tubes are brushed stainless steel

*Ange glastjocklek vid beställning! Glas kan levereras som tillval. valfritt: stolpar finns i rostfritt stål 304 eller 316
*Please specify glass thickness when ordering! Glass panels and u profiles can be supplied optionally. optional: posts are available in 304 or 316 stainless steel

Set-3098: Tre sektioner(2x90°) utan öppning | 3 panels (90°) without passthrough

MADE
IN
GERMANY

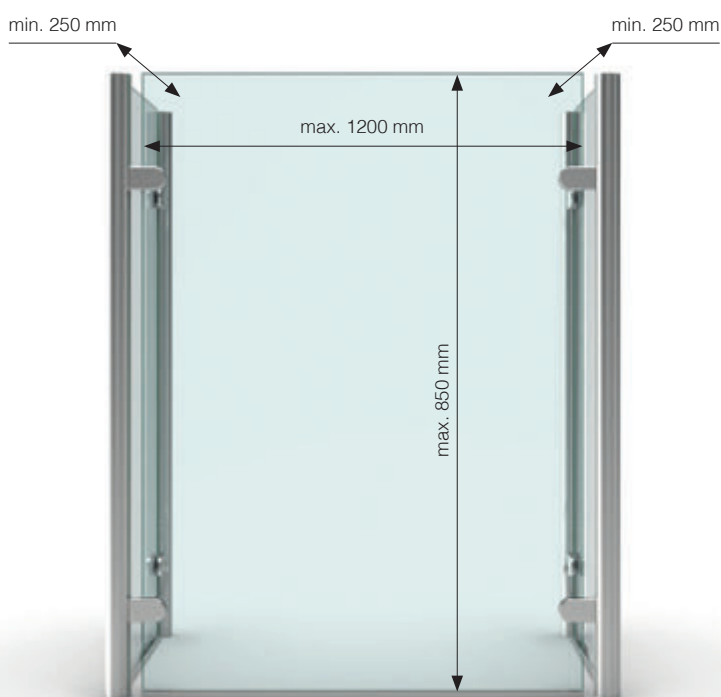

3030/3031

Artikel nr. article no	Glastjocklek glass thickness
Set-3098	4/6 mm*
Yta finish	
ZN12	Grålackad finish Aluminium look, powder coated
ZN22	RF Finish stainless steel optic
RAL	Specialfinish - valfri RAL all colors available on request

Rör i RF material | tubes are brushed stainless steel

*Ange glastjocklek vid beställning! Glas kan levereras som tillval. valfritt: stolpar finns i rostfritt stål 304 eller 316
*Please specify glass thickness when ordering! Glass panels and u profiles can be supplied optionally. optional: posts are available in 304 or 316 stainless steel

Set-3097: Två sektioner(90°) utan öppning | 2 panels (90°) without pass-through

MADE
IN
GERMANY

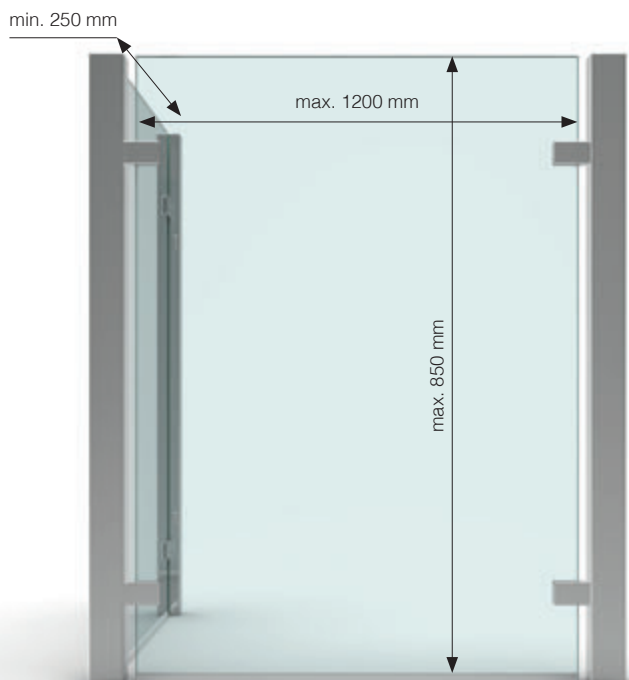

Artikel nr. article no	Glastjocklek glass thickness
Set-3097	4/6 mm*
Yta finish	
ZN12	Grålackad finish Aluminium look, powder coated
ZN22	RF Finish stainless steel optic
RAL	Specialfinish - valfri RAL all colors available on request

Rör i RF material | tubes are brushed stainless steel

*Ange glastjocklek vid beställning! Glas kan levereras som tillval. valfritt: stolpar finns i rostfritt stål 304 eller 316
*Please specify glass thickness when ordering! Glass panels and u profiles can be supplied optionally. optional: posts are available in 304 or 316 stainless steel

Set-3096: Tre sektioner(2x90°) utan öppning | 3 panels (90°) without pass-through

MADE
IN
GERMANY

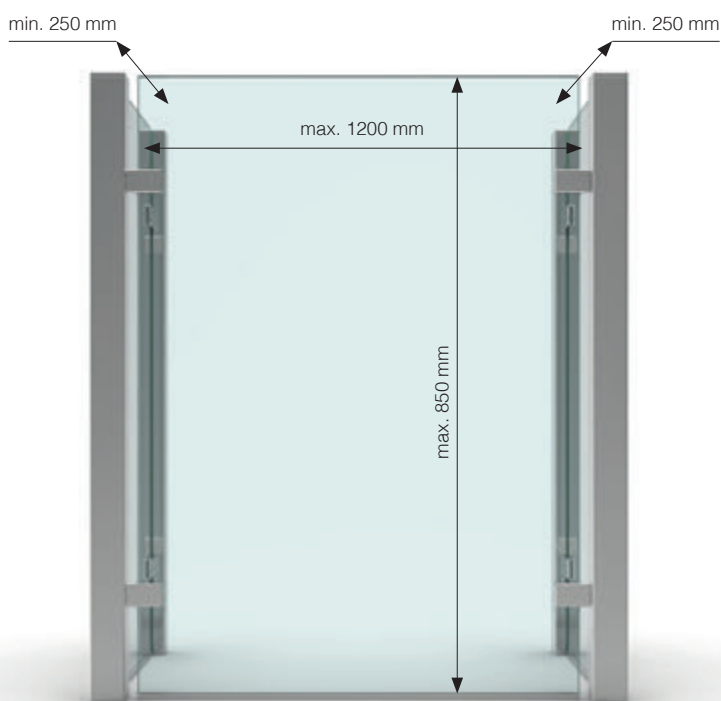

Artikel nr. article no	Glastjocklek glass thickness
Set-3096	4/6 mm*
Yta finish	
ZN12	Grålackad finish Aluminium look, powder coated
ZN22	RF Finish stainless steel optic
RAL	Specialfinish - valfri RAL all colors available on request

Rör i RF material | tubes are brushed stainless steel

*Ange glastjocklek vid beställning! Glas kan levereras som tillval. valfritt: stolpar finns i rostfritt stål 304 eller 316
*Please specify glass thickness when ordering! Glass panels and u profiles can be supplied optionally. optional: posts are available in 304 or 316 stainless steel

Set-3094: Två sektioner(90°) utan öppning | 2 panels (90°) without passthrough

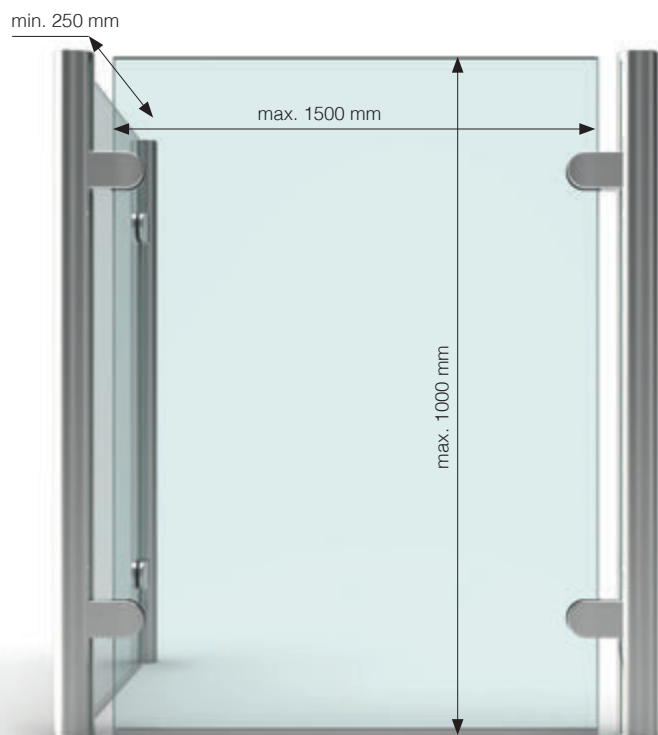

Artikel nr. article no	Glastjocklek glass thickness
Set-3094	6-10,76 mm*
Yta finish	
VA2	Rostfritt - mattborstat utseende stainless steel matt brushed

*Ange glastjocklek vid beställning! Glas kan levereras som tillval. valfritt: stolpar finns i rostfritt stål 304 eller 316

*Please specify glass thickness when ordering! Glass panels and u profiles can be supplied optionally. optional: posts are available in 304 or 316 stainless steel

Set-3095: Tre sektioner(2x90°) utan öppning | 3 panels (90°) without passthrough

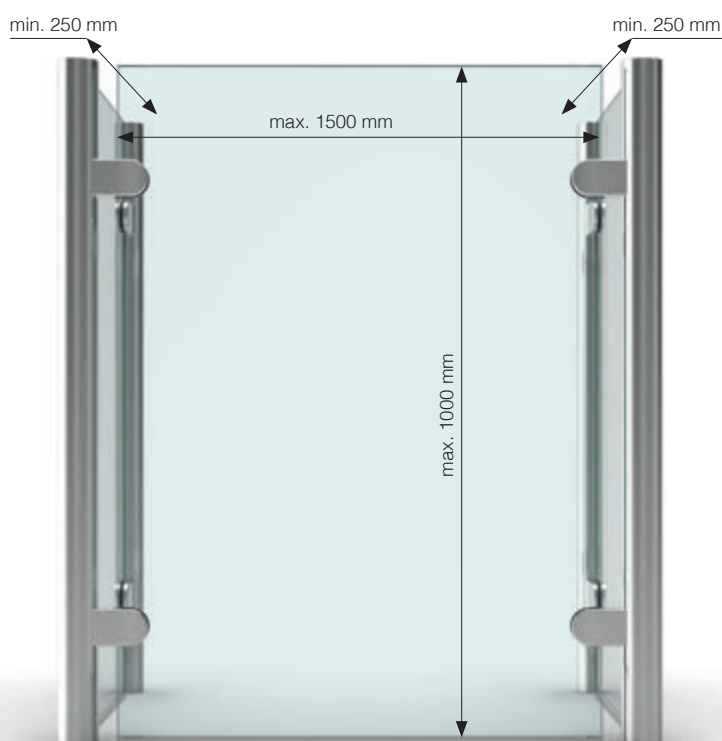

Artikel nr. article no	Glastjocklek glass thickness
Set-3095	6-10,76 mm*
Yta finish	
VA2	Rostfritt - mattborstat utseende stainless steel matt brushed

*Ange glastjocklek vid beställning! Glas kan levereras som tillval. valfritt: stolpar finns i rostfritt stål 304 eller 316

*Please specify glass thickness when ordering! Glass panels and u profiles can be supplied optionally. optional: posts are available in 304 or 316 stainless steel



Tillbehör för montage av stolpar | accessories for sets with post



LOCTITE® 638 Lim LOCTITE® 638 Special adhesive	
<ul style="list-style-type: none"> <input type="checkbox"/> Kort härdningstid <input type="checkbox"/> Hög styrka <input type="checkbox"/> DVGW testad 	<ul style="list-style-type: none"> <input type="checkbox"/> Short bonding time <input type="checkbox"/> High strength <input type="checkbox"/> DVGW-Tested
Artikel nr. Art. no.	Innehåll Content
1023300CTP	10 ml-tub 10-ml-Bottle
1023310CTP	50 ml-tub 50-ml-Bottle



Artikel nr. article no	
4820VA	 säkerhetsstift för set 3085/3086 safety stud for Set-3085/3086

Montageskruvar till klämfäste INGÅR EJ. V g och upplys om detta vid beställning.
 Holes for safety studs are not shown in the glass drawings, if desired, please enquire when ordering.

Set-3092: Tre sektioner(2x90°) utan öppning | 3 panels (90°) without pass-through

MADE
IN
GERMANY

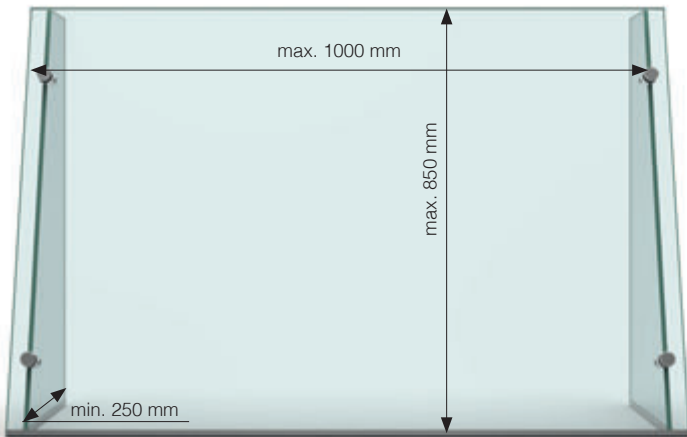

Artikel nr. article no	Glastjocklek glass thickness
Set-3092	6-10 mm*
Yta finish	
ZN5	Blankkrom gloss chrome
ZN22	RF Finish stainless steel optic
RAL	Specialfinish - valfri RAL all colors available on request

*Ange glastjocklek vid beställning! Glas kan levereras som tillval.
*Please specify glass thickness when ordering! Glass panels can be supplied optionally.



Set-3081: Tre sektioner(2x135°) med öppning | 3 panels (135°) with pass-through

MADE
IN
GERMANY

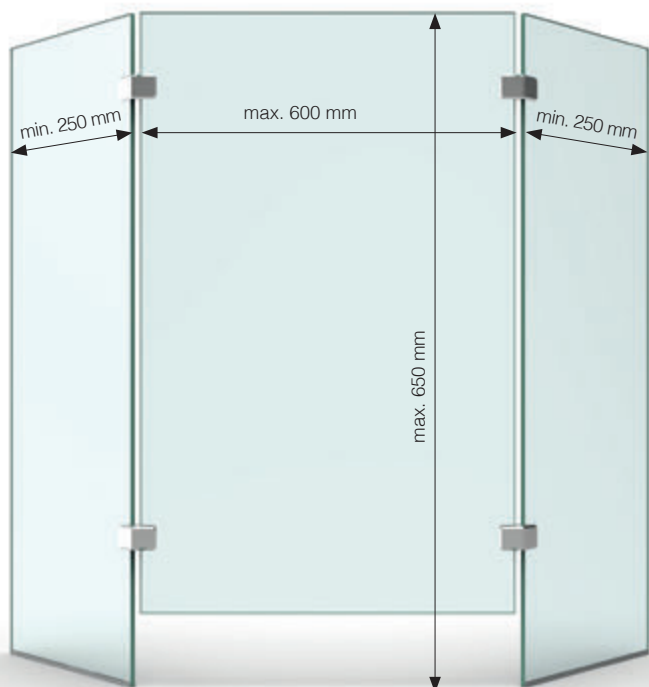

4884

Artikel nr. article no	Glastjocklek glass thickness
Set-3081	5–8 mm*
Yta finish	
ZN5	Blankkrom gloss chrome
ZN22	RF Finish stainless steel optic
RAL	Specialfinish - valfri RAL all colors available on request

*Ange glastjocklek vid beställning! Glas kan levereras som tillval.
*Please specify glass thickness when ordering! Glass panels can be supplied optionally.

Set-3082: Tre sektioner(2x90°) med öppning | 3 panels (90°) with pass-through

MADE
IN
GERMANY



4885

Artikel nr. article no	Glastjocklek glass thickness
Set-3082	5–8 mm*
Yta finish	
ZN5	Blankkrom gloss chrome
ZN22	RF Finish stainless steel optic
RAL	Specialfinish - valfri RAL all colors available on request

*Ange glastjocklek vid beställning! Glas kan levereras som tillval.
*Please specify glass thickness when ordering! Glass panels can be supplied optionally.

Set-3093: En sektion med öppning | panel with pass-through

MADE
IN
GERMANY

Tillgänglig sommar 2020
available in summer 2020

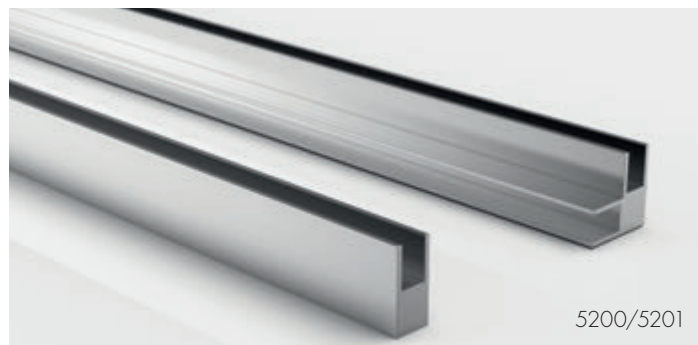
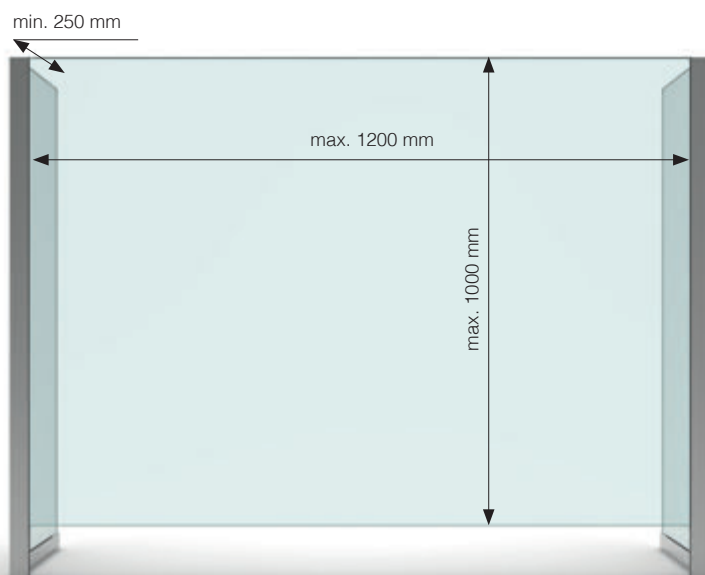

Artikel nr. article no	Glastjocklek glass thickness
Set-3093	≤ 8 mm*
Yta finish	
E6EV1	Naturadoniserad, silvergrå finish Aluminium look, anoised silver
RAL	Specialfinish - valfri RAL all colors available on request

*Ange glastjocklek vid beställning! Glas kan levereras som tillval.
*Please specify glass thickness when ordering! Glass panels can be supplied optionally.

Set-3075: Tre sektioner(2x135°) med öppning | 3 panels (135°) with pass-through

MADE
IN
GERMANY

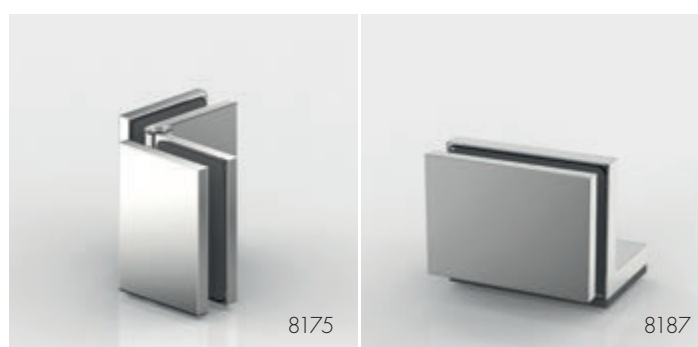
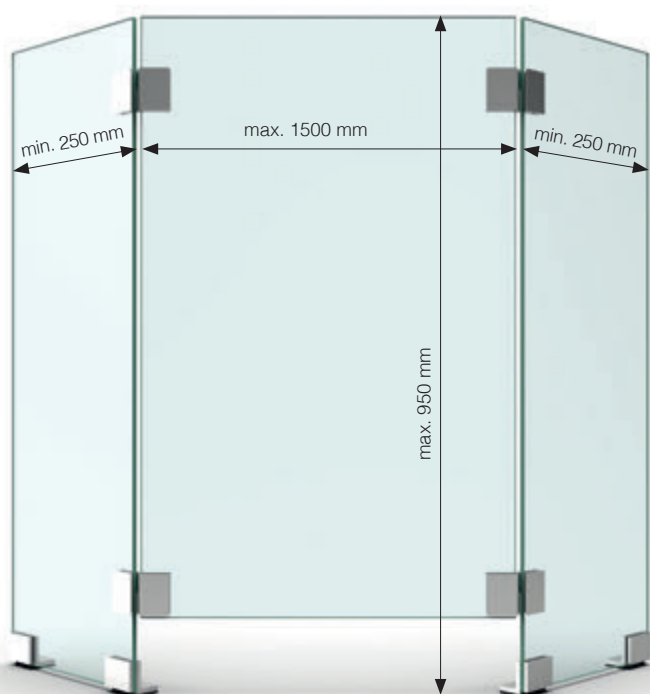

Artikel nr. article no	Glastjocklek glass thickness
Set-3075	6/8/10 mm*
Yta finish	
ZN5	Blankrom gloss chrome
ZNPVD22	RF Finish stainless steel optic
ZN35	Svartlackad black
RAL	Specialfinish - valfri RAL all colors available on request

*Ange glastjocklek vid beställning! Glas kan levereras som tillval.
*Please specify glass thickness when ordering! Glass panels can be supplied optionally.

Glasdimensioner | glass processing

Artikel nr. article no	Glastjocklek glass thickness
Glas-3078-V Glas för Set-3078 glass for Set-3078	4/6 mm*

Sida | page 04

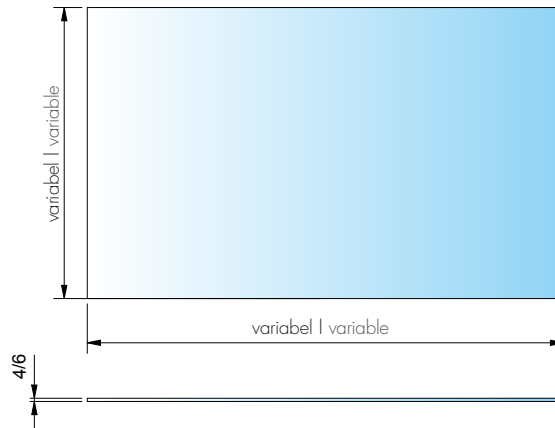

Artikel nr. article no	Glastjocklek glass thickness
Glas-3079-V Glas för Set-3079 glass for Set-3079	4/6 mm*

Sida | page 04

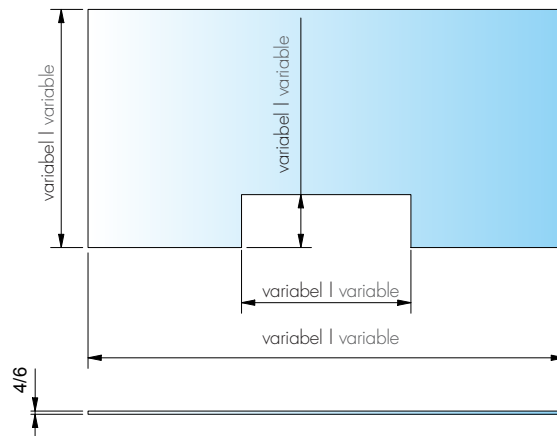

Artikel nr. article no	Glastjocklek glass thickness
Glas-3078-V Glas för Set-3077 glass for Set-3077	4/6 mm*

Sida | page 05

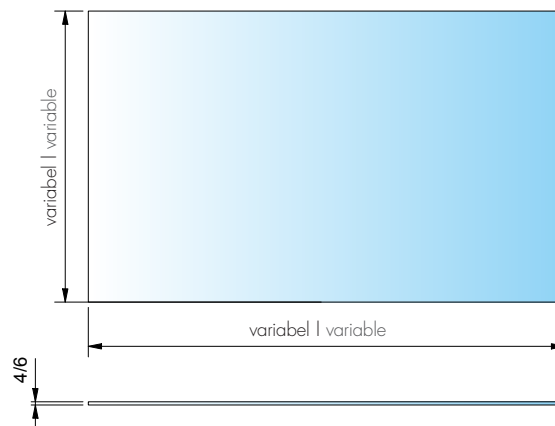

*Ange glastjocklek vid beställning!
*Please specify glass thickness when ordering!

Glasdimensioner | glass processing

Artikel nr. article no	Glastjocklek glass thickness
Glas-3079-V Glas för Set-3076 glass for Set-3076	4/6 mm*

Sida | page 05

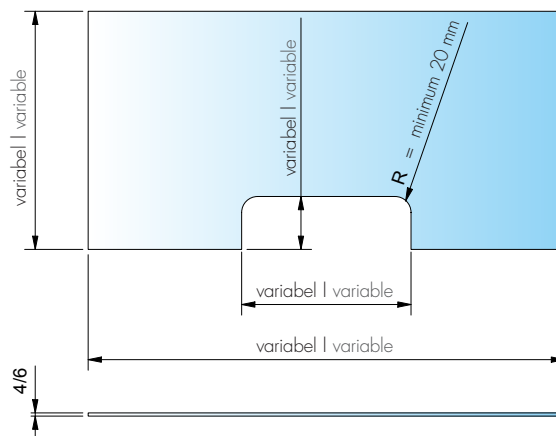

Artikel nr. article no	Glastjocklek glass thickness
Glas-3087-V Glas för Set-3087 glass for Set-3087	6-12,76 mm*

Sida | page 06

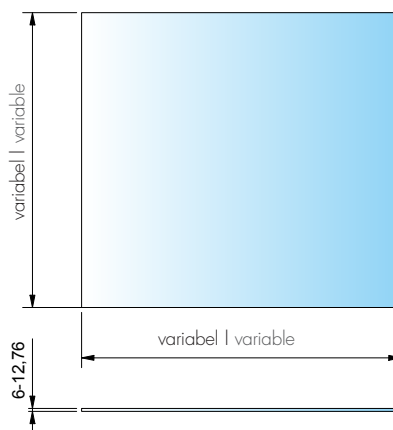

Artikel nr. article no	Glastjocklek glass thickness
Glas-3088-V Glas för Set-3088 glass for Set-3088	6-12,76 mm*

Sida | page 06

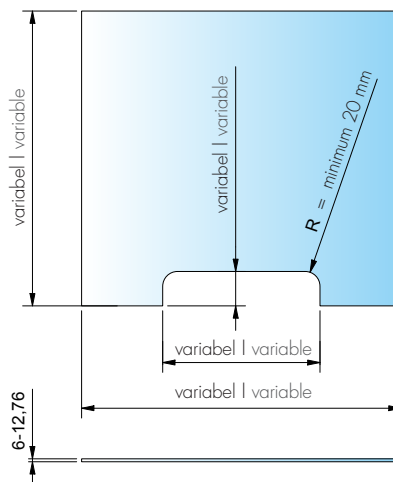

*Ange glastjocklek vid beställning!
*Please specify glass thickness when ordering!

Glasdimensioner | glass processing

Artikel nr. article no	Glastjocklek glass thickness
Glas-3087-V Glas för Set-3085 glass for Set-3085	6-12,76 mm*

Sida | page 07

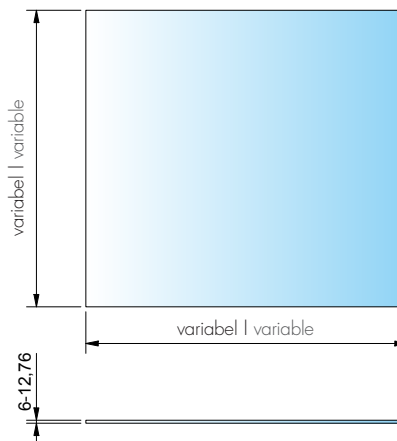

Artikel nr. article no	Glastjocklek glass thickness
Glas-3088-V Glas för Set-3086 glass for Set-3086	6-12,76 mm*

Sida | page 07

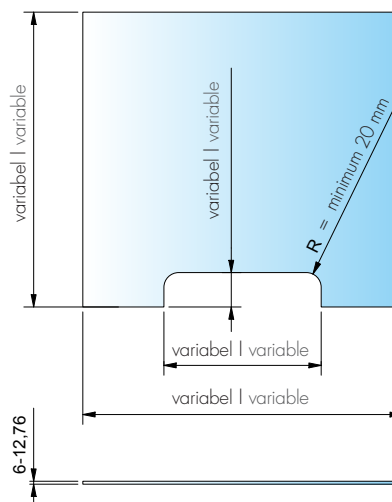

Artikel nr. article no	Glastjocklek glass thickness
Glas-3083-V Glas för Set-3083 glass for Set-3083	6/8/10 mm*

Sida | page 08

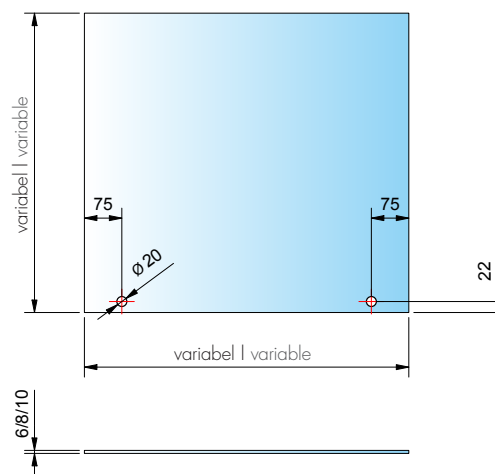

*Ange glastjocklek vid beställning!
*Please specify glass thickness when ordering!

Glasdimensioner | glass processing

Artikel nr. article no	Glastjocklek glass thickness
---------------------------	---------------------------------

Glas-3084-V Glas för Set-3084 6/8/10 mm*
glass for Set-3084

Sida | page 08

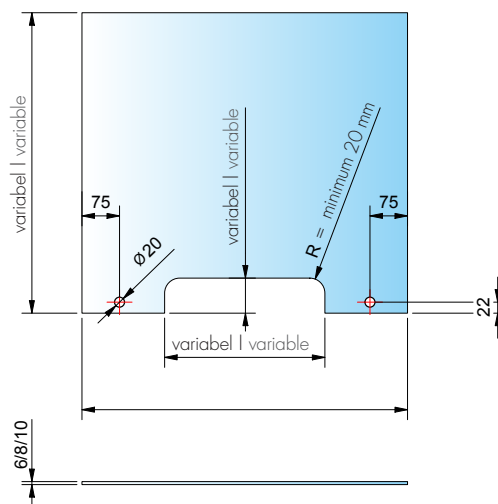

Artikel nr. article no	Glastjocklek glass thickness
---------------------------	---------------------------------

Glas-3089-V Glas för Set-3089 8-12,76 mm*
glass for Set-3089

Sida | page 09

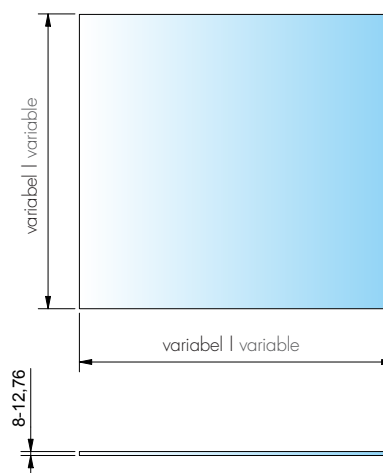

Artikel nr. article no	Glastjocklek glass thickness
---------------------------	---------------------------------

Glas-3074-V Glas för Set-3074 6-10 mm*
glass for Set-3074

Sida | page 10

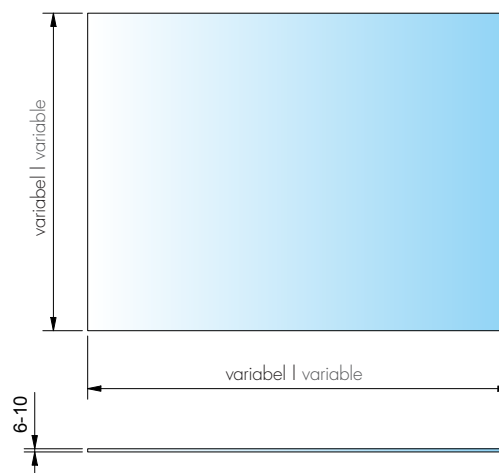

*Ange glastjocklek vid beställning!
*Please specify glass thickness when ordering!

Glasdimensioner | glass processing

Artikel nr. article no	Glastjocklek glass thickness
Glas-3090-V Glas för Set-3090 glass for Set-3090	6-10 mm*

Sida | page 10

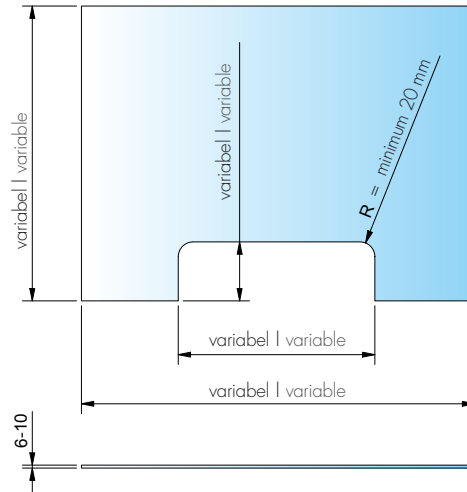

Artikel nr. article no	Glastjocklek glass thickness
Glas-3063-V Glas för Set-3063 glass for Set-3063	6 mm*

Sida | page 11

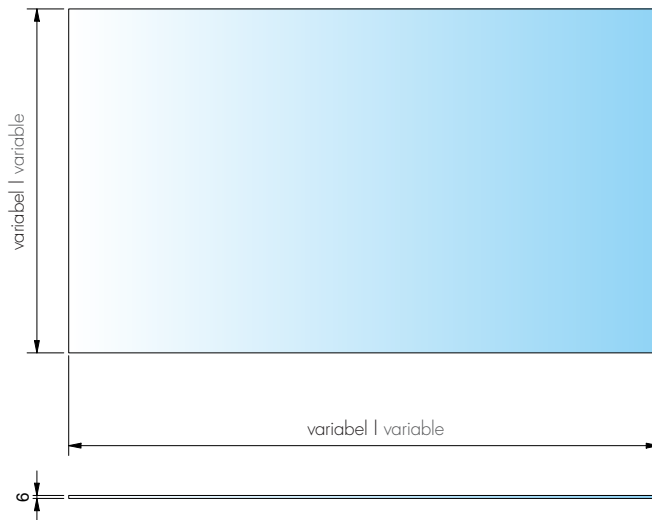

Artikel nr. article no	Glastjocklek glass thickness
Glas-3062-V Glas för Set-3062 glass for Set-3062	6 mm*

Sida | page 11

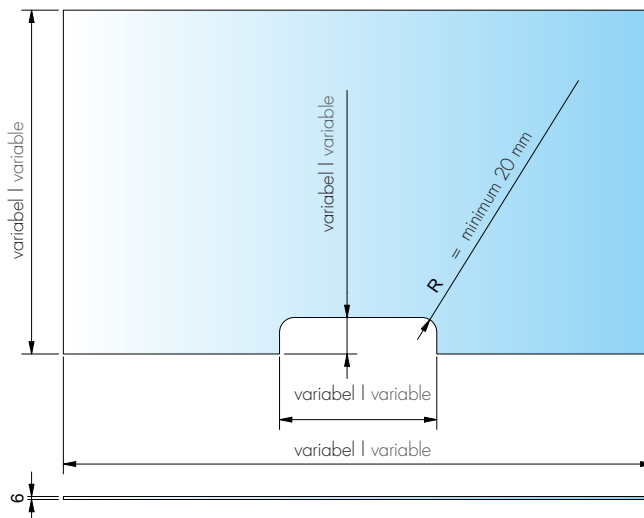

*Ange glastjocklek vid beställning!
*Please specify glass thickness when ordering!

Glasdimensioner | glass processing

Artikel nr. article no	Glastjocklek glass thickness
Glas-3098-1-V Glas för Set-3098	4/6 mm*
Glas-3098-2-V glass for Set-3098	

Sida | page 12

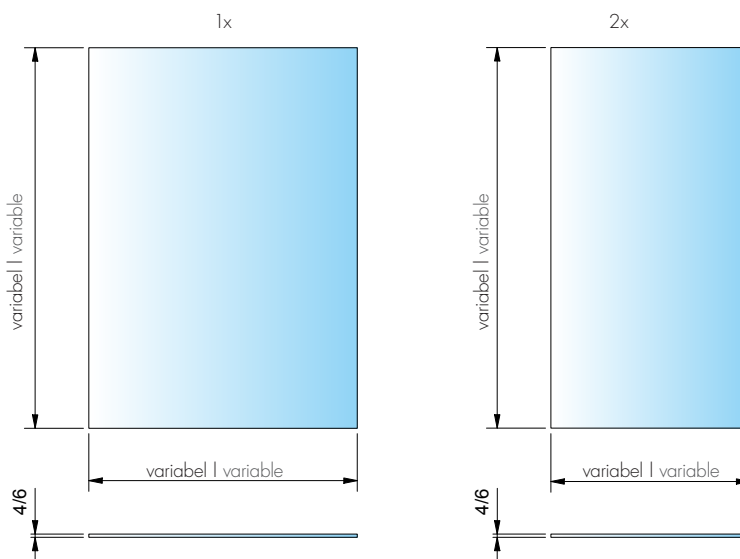

Artikel nr. article no	Glastjocklek glass thickness
Glas-3098-1-V Glas för Set-3099	4/6 mm*
Glas-3098-2-V glass for Set-3099	

Sida | page 12

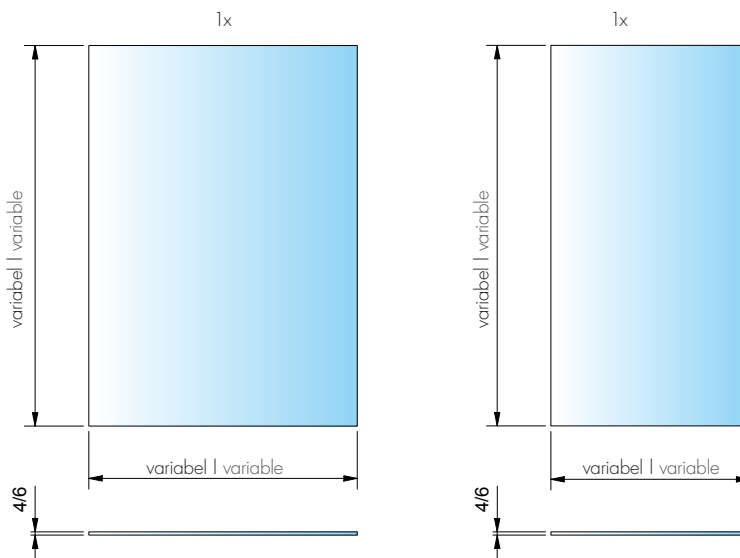

Artikel nr. article no	Glastjocklek glass thickness
Glas-3098-1-V Glas för Set-3096	4/6 mm*
Glas-3098-2-V glass for Set-3096	

Sida | page 13

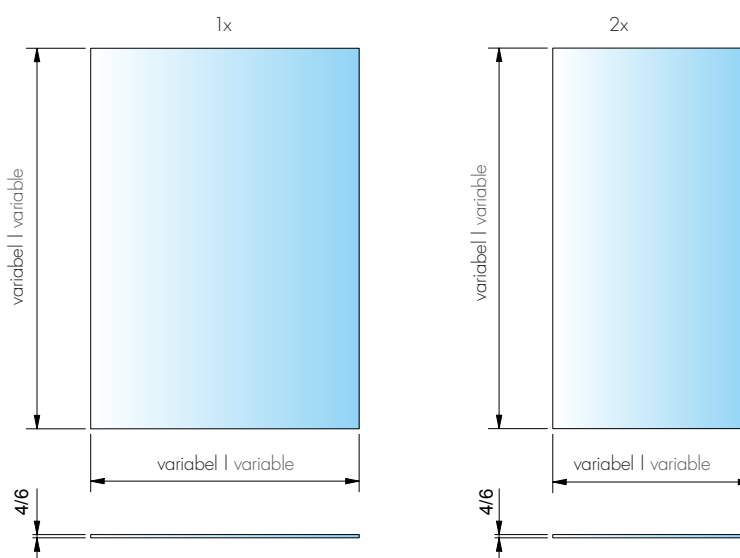

*Ange glastjocklek vid beställning!
*Please specify glass thickness when ordering!

Glasdimensioner | glass processing

Artikel nr. article no	Glastjocklek glass thickness
Glas-3098-1-V	Glas för Set-3097 4/6 mm*
Glas-3098-2-V	glass for Set-3097

Sida | page 13

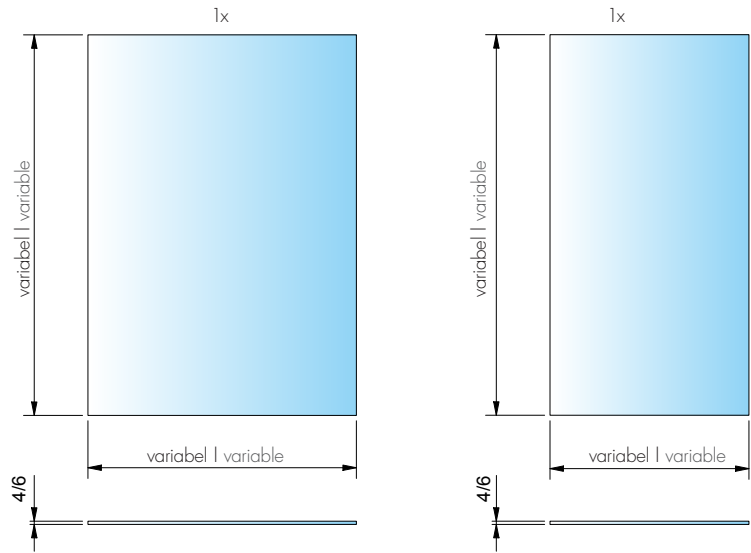

Artikel nr. article no	Glastjocklek glass thickness
Glas-3094-1-V	Glas för Set-3094 6-10,76 mm*
Glas-3094-2-V	glass for Set-3094

Sida | page 14

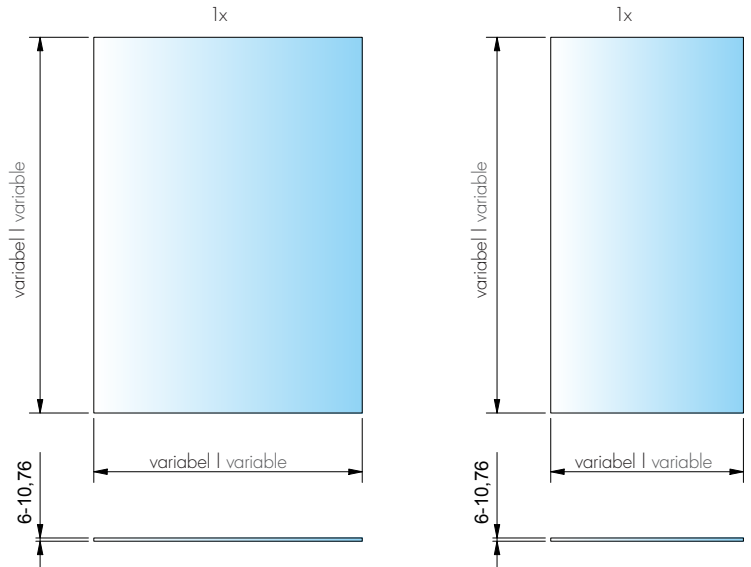

Artikel nr. article no	Glastjocklek glass thickness
Glas-3094-1-V	Glas för Set-3095 6-10,76 mm*
Glas-3094-2-V	glass for Set-3095

Sida | page 14

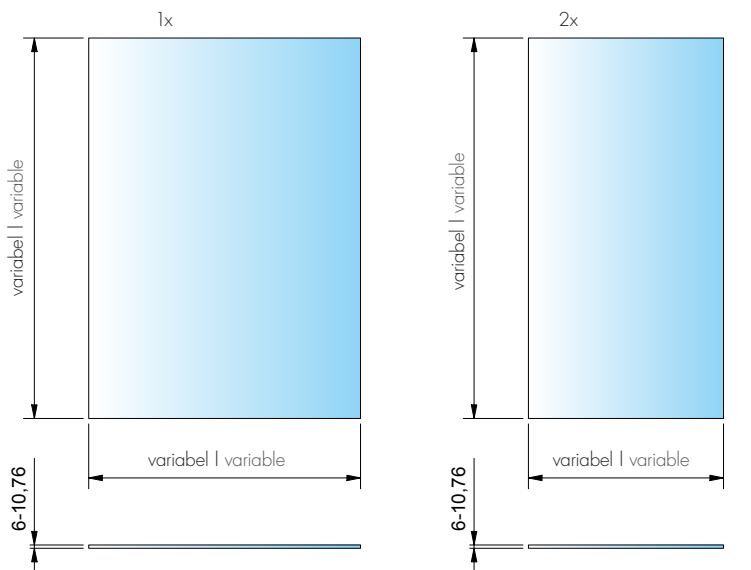

*Ange glastjocklek vid beställning!
*Please specify glass thickness when ordering!

Glasdimensioner | glass processing

Artikel nr. article no	Glastjocklek glass thickness
Glas-3092-1-V	Glas för Set-3092 6-10 mm*
Glas-3092-2-V	glass for Set-3092

Sida | page 16

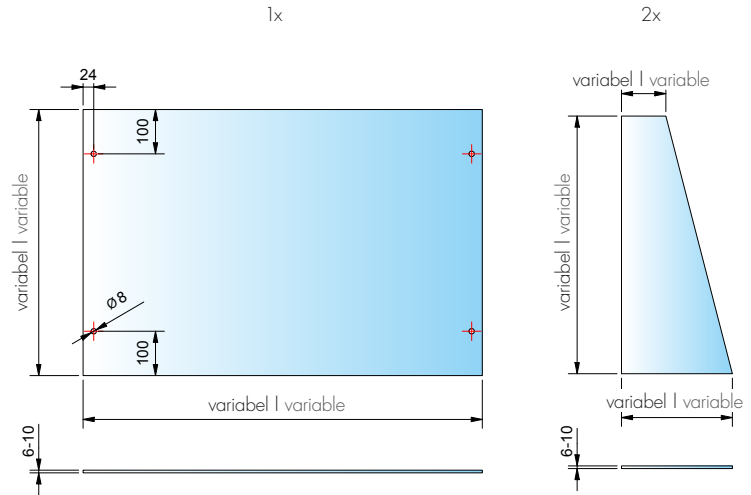

Artikel nr. article no	Glastjocklek glass thickness
Glas-3081-1-V	Glas för Set-3081 5-8 mm*
Glas-3081-2-V	glass for Set-3081

Sida | page 17

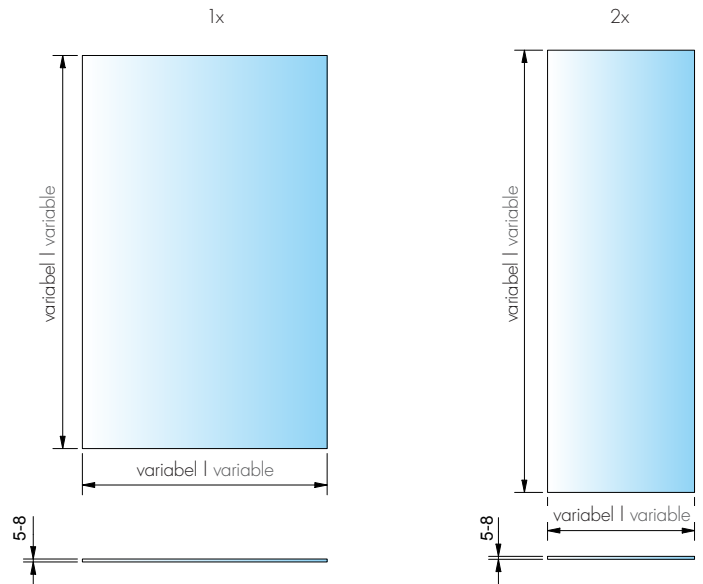

Artikel nr. article no	Glastjocklek glass thickness
Glas-3081-1-V	Glas för Set-3082 5-8 mm*
Glas-3081-2-V	glass for Set-3082

Sida | page 17

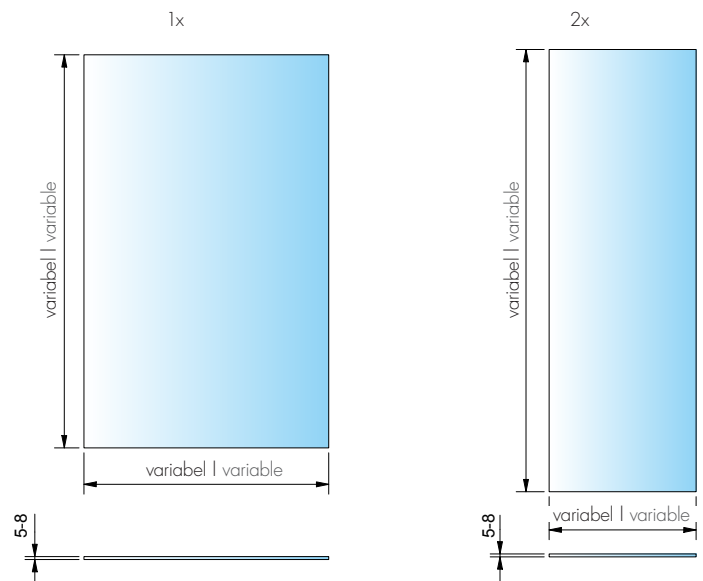

*Ange glastjocklek vid beställning!
*Please specify glass thickness when ordering!

Glasdimensioner | glass processing

Artikel nr. article no	Glastjocklek glass thickness
Glas-3093-1-V	Glas för Set-3093 ≤ 8 mm*
Glas-3093-2-V	glass for Set-3093

Sida | page 18

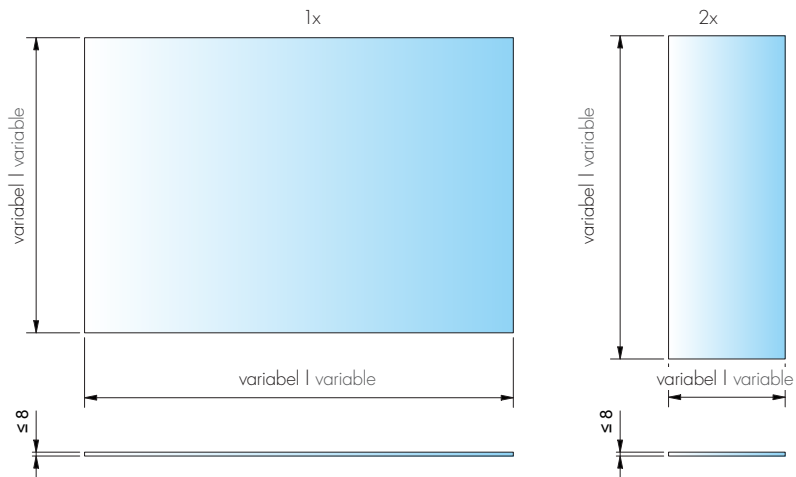

Artikel nr. article no	Glastjocklek glass thickness
Glas-3075-1-V	Glas för Set-3075 6/8/10 mm*
Glas-3075-2-V	glass for Set-3075

Sida | page 18

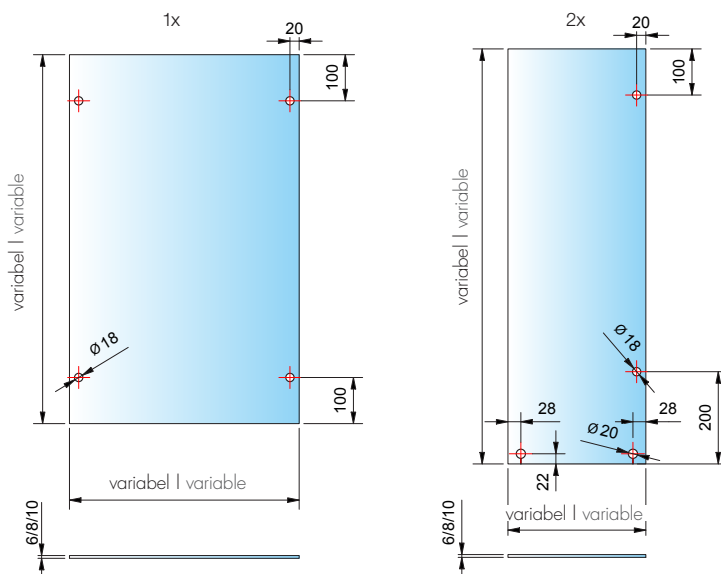

Pauli Scandinavia AB 
Member of Pauli + Sohn GmbH group

Pauli Scandinavia AB

Fågelviksvägen 18, Hus 3,
145 53 Norsborg

Tel. +46 8 449 32 00

Fax +46 8 449 32 01

Internet

Website: www.pauliscand.se

E-Mail: info@pauliscand.se