



Duschen - Black Edition

Showers - Black Edition







Inhalt

Content

Duschtürband PAVONE Shower door hinge PAVONE	06
Duschtürband FLAMEA+ Shower door hinge FLAMEA+	16
Sauna-Pendeltürband - FLAMEA+ Sauna swing door hinge - FLAMEA+	28
Duschtürband FARFALLA Shower door hinge FARFALLA	32
Griffe Door Handles	36
U-Profil U-profile	41
Stabilisationsstangen Supporting bars	42
Dichtprofile Sealing profiles	46



PAVONE

Black
EDITION

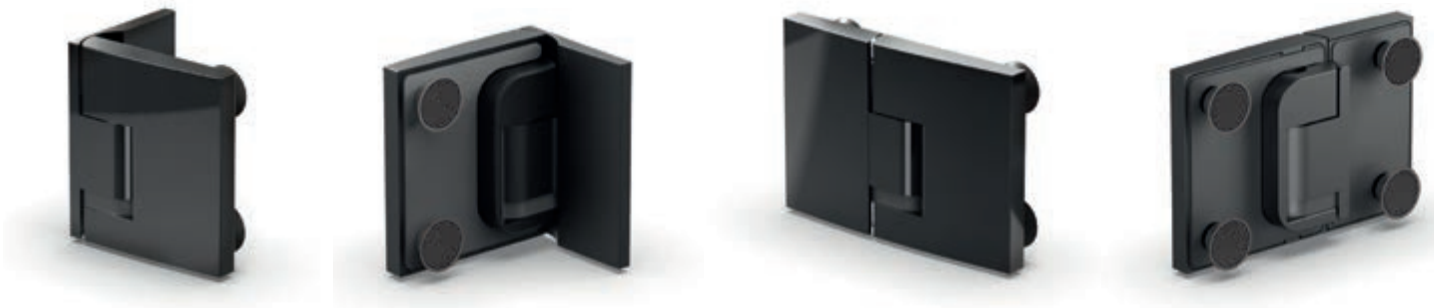

PAVONE wurde mit dem Ziel entwickelt, die positiven Eigenschaften verschiedener Duschtürbänder in einer Serie zu vereinen. Die Flächenbündigkeit für einen hohen Reinigungskomfort wird kombiniert mit den Vorzügen der Pendelfunktion. Außerdem hebt sich die Tür im Öffnungsvorgang an und senkt sich im Schließvorgang in eine stufenlos justierbare Nulllage. Diese Serie spielt Ihre Stärken bei einer barrierefreien Badplanung mit hohem Anspruch an die Ästhetik der Duschkabine aus.

- beidseitig 90° öffnendes Duschpendeltürband
- Hebe-Senkfunktion
- mit flächenbündiger Verschraubung
- im Senkvorgang selbst schließend
- stufenlose Nulllageneinstellung
- Tragfähigkeit (2 Bänder): 36 kg entsprechen einer maximalen Türflügelgröße von 900 x 2000 mm bei 8 mm Glasdicke
- optimiert für die Verbauung ohne Dichtprofil je nach baulicher Situation (3mm Luft zur Wand bei geänderter Glasbearbeitung mit Gehrungskante)
- Die Haltbarkeit der Beschläge wurde durch werksinterne Versuche nach DIN EN 14428:2015 5.5 geprüft.

PAVONE was developed with the aim of combining the positive characteristics of different shower hinges into one series. The flush design for cleaning comfort is combined with the advantages of the pendulum function. In addition, the door lifts during the opening process and descends while closing offering an infinite adjustable closing position. This series shows its advantages in barrier-free bathroom planning with high demands on aesthetics of the shower enclosure.

- 90° opening in both directions
- lifting function
- with flush screws
- Self-Closing during the lowering process
- infinitely variable closed position adjustment
- load capacity (2 hinges): 36 kg Corresponds to a maximum door panel size of 900 x 2000mm with 8 mm glass thickness
- optimized for assembly without seals depending on the building situation (3mm gap to the wall with modified glass processing using a mitered edge)
- the durability of the hardware has been tested internally in accordance with DIN EN 14428:2015 5.5.

Duschtürband – PAVONE

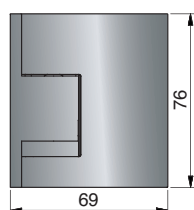
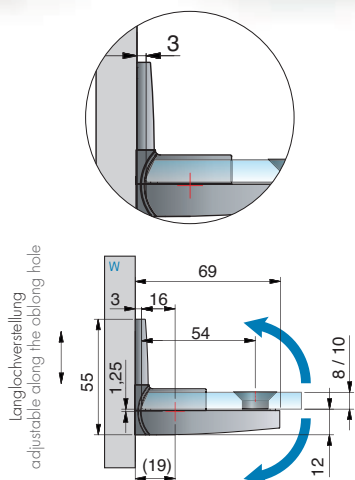

Glasbearbeitung für 8 mm
ohne Dichtprofil
glass processing for 8 mm without
sealing profile

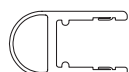
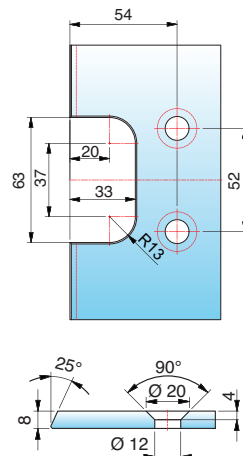

Dichtprofil ausklinken
notch sealing profile

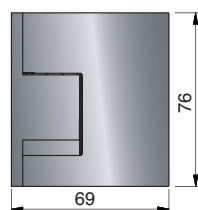
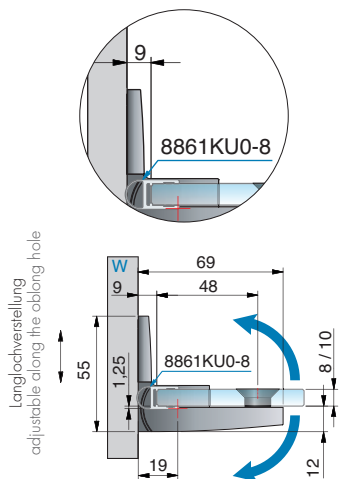

Glasbearbeitung für 8 mm
mit Dichtprofil 8861KU0-8-2010
glass processing for 8 mm with
sealing profile 8861KU0-8-2010

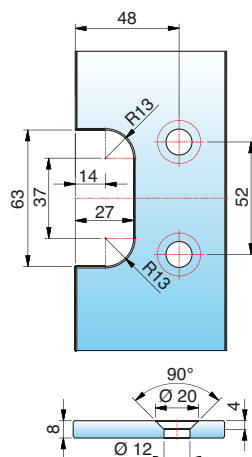

**Black
EDITION**

Art.-Nr. Art.-no.	Oberfläche Finish	Glasdicke Glass thickness	Artikelbezeichnung Article name	Merkmale Features	VE/Stück Pu/pieces
8390ZNPVD35-L	Schwarz matt Matt black	8/10 mm	PAVONE – Pendeltürband Glas-Wand 90° links montiert, beidseitig öffnend PAVONE – Shower swing door hinge glass-wall 90° Mounted on the left, opening in both directions	Glasbefestigung flächenbündig, Wandanschraubplatte innen, verdeckte Verschraubung mit Abdeckkappe, Punkthalter unabhängig voneinander ± 2 mm in jede Richtung verstellbar, Nulllage einstellbar. Verbaung ohne seitliche Dichtung durch geänderte Glasbearbeit- ung möglich. glass fixtures flush, wall mount inside, concealed screws with cover cap, point fixture assembly adjustable inde- pendent of each other ± 2 mm in any direction, closed position adjustable. Assembly without side seal possible with altered glass processing.	1/2
8390ZNPVD36-L	Schwarz glänzend Gloss black				

MADE
IN
GERMANY



Glasbearbeitung für 8 mm ohne Dichtprofil
glass processing for 8 mm without sealing profile

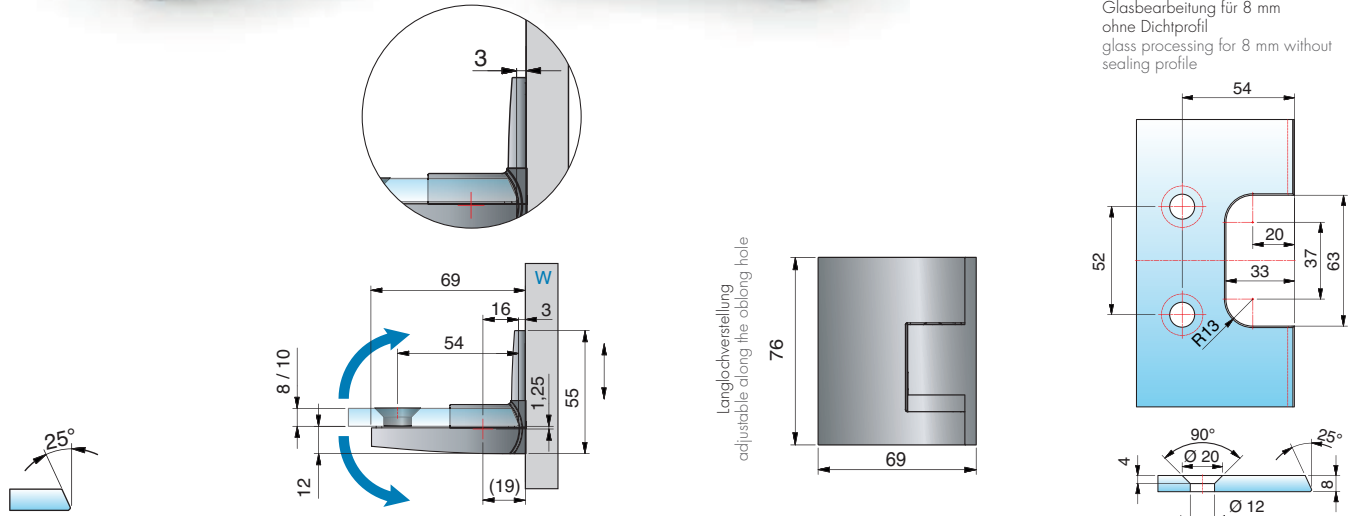

Glasbearbeitung für 8 mm mit Dichtprofil 8861KU0-8-2010
glass processing for 8 mm with sealing profile 8861KU0-8-2010

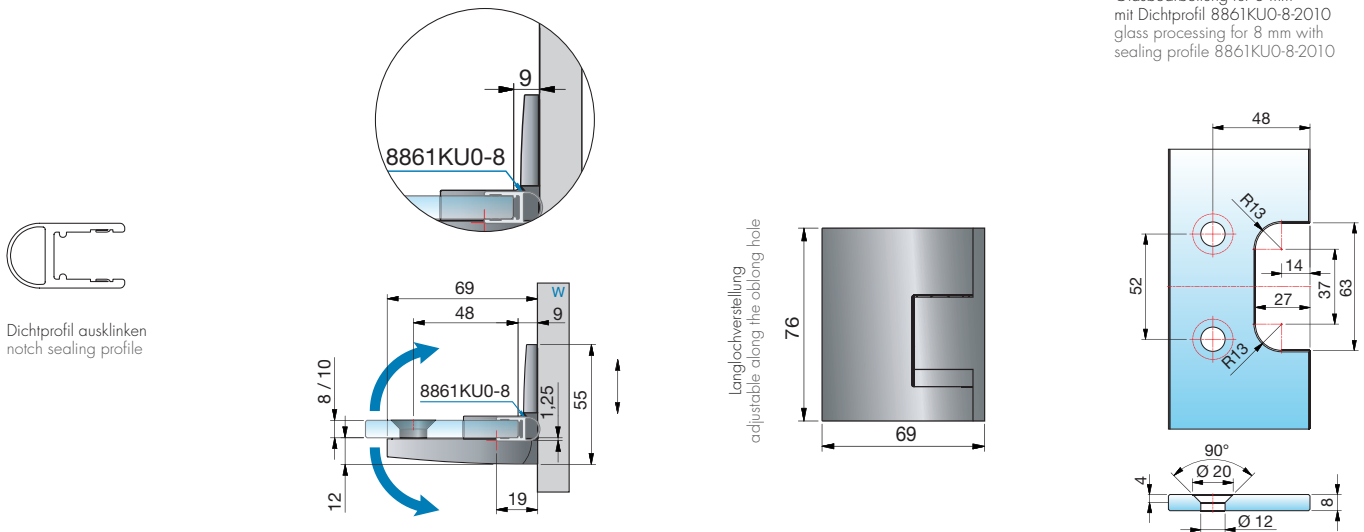

Black EDITION

Art.-Nr. Art.-no.	Oberfläche Finish	Glasdicke Glass thickness	Artikelbezeichnung Article name	Merkmale Features	VE/Stück Pu/pieces
8390ZNPVD35-R	Schwarz matt Matt black	8/10 mm	PAVONE – Pendeltürband Glas-Wand 90° rechts montiert, beidseitig öffnend PAVONE – Shower swing door hinge glass-wall 90° Mounted on the right, opening in both directions	Glasbefestigung flächenbündig, Wandanschraubplatte innen, verdeckte Verschraubung mit Abdeckkappe, Punkthalter unabhängig voneinander ± 2 mm in jede Richtung verstellbar, Nulllage einstellbar. Verbauung ohne seitliche Dichtung durch geänderte Glasbearbeitung möglich. glass fixtures flush, wall mount inside, concealed screws with cover cap, point fixture assembly adjustable independent of each other ± 2 mm in any direction, closed position adjustable. Assembly without side seal possible with altered glass processing.	1/2
8390ZNPVD36-R	Schwarz glänzend Gloss black				

MADE
IN
GERMANY

Duschtürband – PAVONE

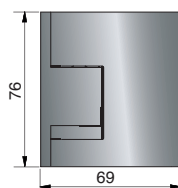
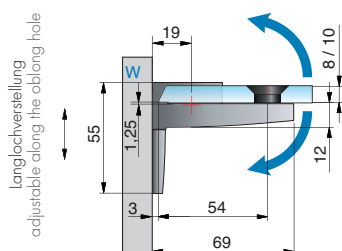
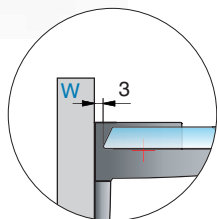

Glasbearbeitung für 8 mm ohne Dichtprofil
glass processing for 8 mm without sealing profile

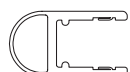
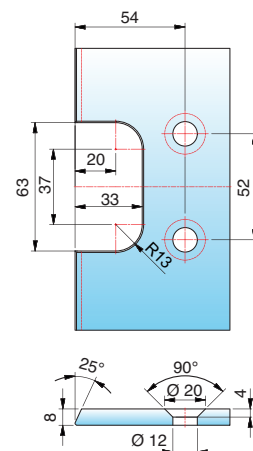

Dichtprofil im Bandbereich ausklinken
notch sealing profile on the hinge side

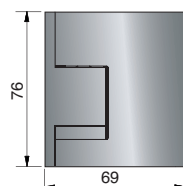
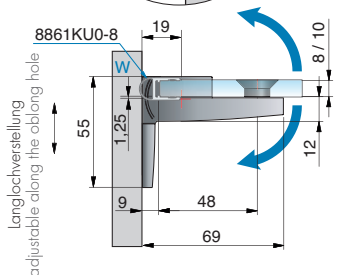
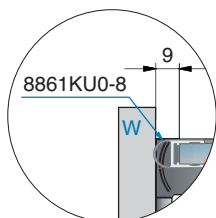

Glasbearbeitung für 8 mm mit Dichtprofil 8861KU0-8-2010
glass processing for 8 mm with sealing profile 8861KU0-8-2010

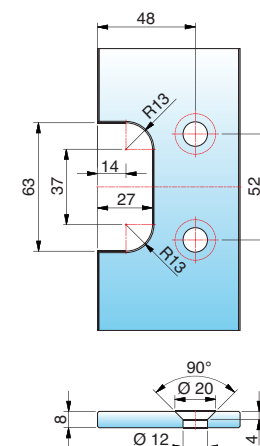

Black EDITION

Art.-Nr. Art.-no.	Oberfläche Finish	Glasdicke Glass thickness	Artikelbezeichnung Article name	Merkmale Features	VE/Stück Pu/pieces
8391ZNPVD35-L	Schwarz matt Matt black	8/10 mm	PAVONE – Pendeltürband Glas-Wand 90° links montiert, beidseitig öffnend PAVONE – shower swing door hinge glass-wall 90° mounted on the left, opening in both directions	Glasbefestigung flächenbündig, Wandlasche ausßen, verdeckte Verschraubung mit Abdeckkappe, Punkthalter unabhängig voneinander ± 2 mm in jede Richtung verstellbar, Nulllage einstellbar. Verbauung ohne seitliche Dichtung durch geänderte Glasbear- beitung möglich. glass fixtures flush, wall mount outside, concealed screws with cover cap, point fixture assembly adjust- able independent of each other ± 2 mm in any di- rection, closed position adjustable. Assembly without side seal possible with altered glass processing.	1/2
8391ZNPVD36-L	Schwarz glänzend Gloss black				

MADE
IN
GERMANY



Glasbearbeitung für 8 mm ohne Dichtprofil
glass processing for 8 mm without sealing profile

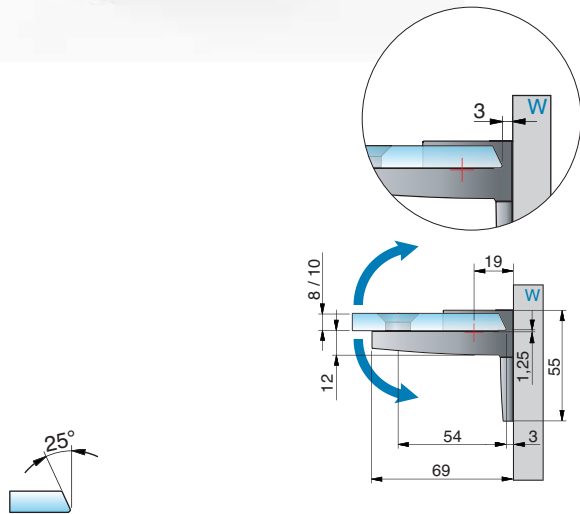

Langlochverstellung
adjustable along the oblong hole

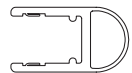
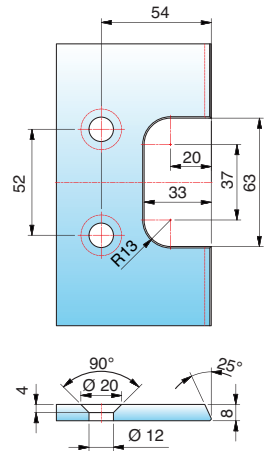
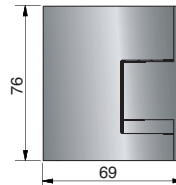

Dichtprofil im Bandbereich ausklinken
notch sealing profile on the hinge side

Glasbearbeitung für 8 mm mit Dichtprofil 8861KU0-8-2010
glass processing for 8 mm with sealing profile 8861KU0-8-2010

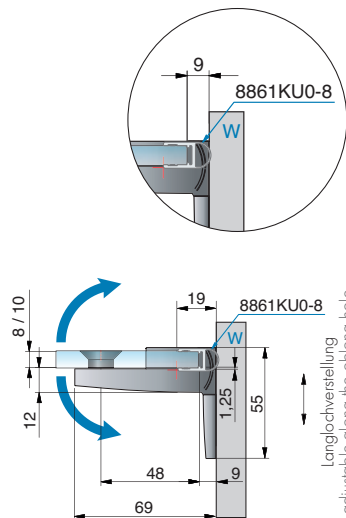

Langlochverstellung
adjustable along the oblong hole

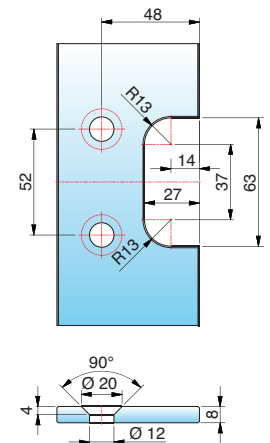
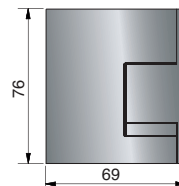

Black EDITION

Art.-Nr. Art.-no.	Oberfläche Finish	Glasdicke Glass thickness	Artikelbezeichnung Article name	Merkmale Features	VE/Stück Pu/pieces
8391ZNPVD35-R	Schwarz matt Matt black	8/10 mm	PAVONE – Pendeltürband Glas-Wand 90° rechts montiert, beidseitig öffnend PAVONE – shower swing door hinge glass-wall 90° mounted on the right, opening in both directions	Glasbefestigung flächenbündig, Wandlasche ausßen, verdeckte Verschraubung mit Abdeckkappe, Punkthalter unabhängig voneinander ± 2 mm in jede Richtung verstellbar, Nulllage einstellbar. Verbauung ohne seitliche Dichtung durch geänderte Glasbear- beitung möglich. glass fixtures flush, wall mount outside, concealed screws with cover cap, point fixture assembly adjust- able independent of each other ± 2 mm in any di- rection, closed position adjustable. Assembly without side seal possible with altered glass processing.	1/2
8391ZNPVD36-R	Schwarz glänzend Gloss black				

MADE
IN
GERMANY

Duschtürband – PAVONE



Glasbearbeitung für 8 mm
ohne Dichtprofil
glass processing for 8 mm
without sealing profile

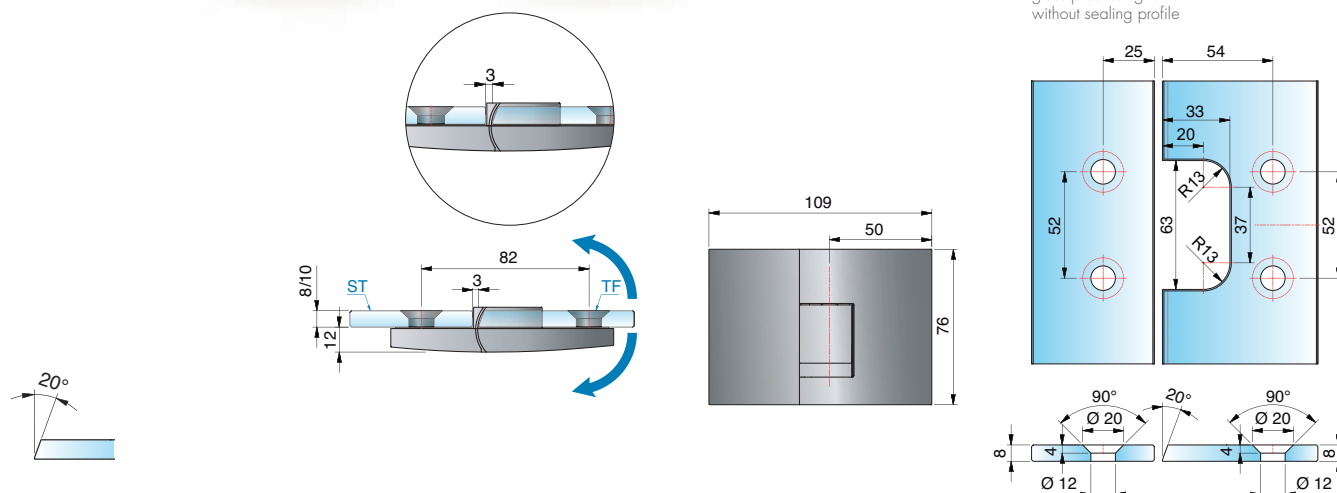

Glasbearbeitung für 8 mm
mit Dichtprofil 8845KU0-8K-2500
glass processing for 8 mm with
sealing profile 8845KU0-8K-2500

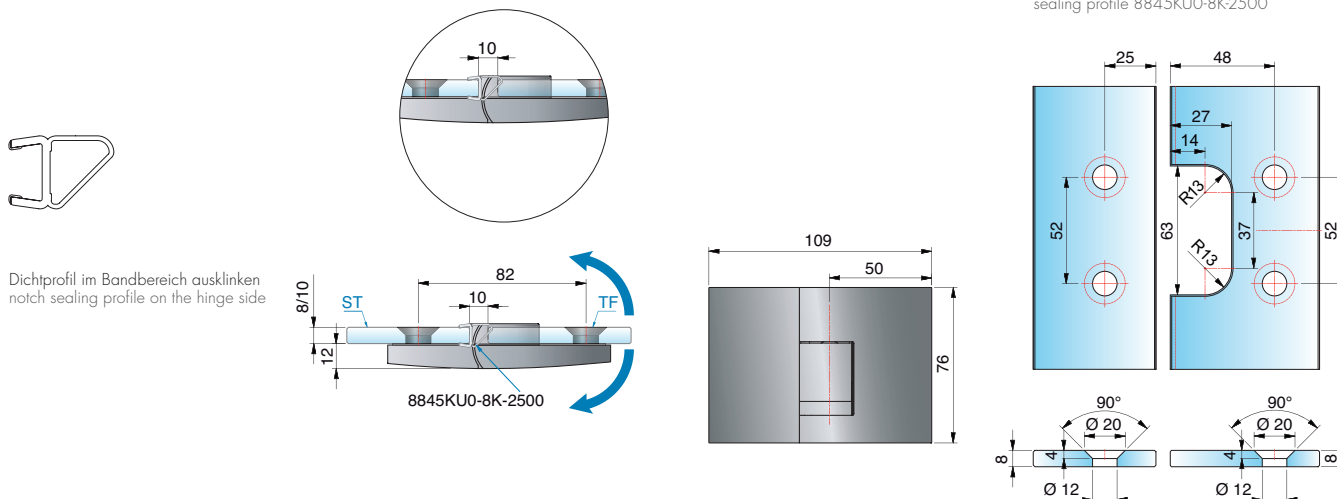

**Black
EDITION**

Art.-Nr. Art.-no.	Oberfläche Finish	Glasdicke Glass thickness	Artikelbezeichnung Article name	Merkmale Features	VE/Stück Pu/pieces
8392ZNPVD35-L	Schwarz matt Matt black	8/10 mm	Pendeltürband – PAVONE Glas-Wand 180°, links montiert, beidseitig öffnend PAVONE – Shower swing door hinge glass-wall 180°, Mounted on the left, opening in both directions	Glasbefestigung flächenbündig, Punkthalter unabhängig voneinander ± 2 mm in jede Richtung verstellbar, Nulllage einstellbar. Verbauung ohne Dichtung durch geänderte Glasbearbeitung möglich. glass fixtures flush, point fixture assembly adjustable independent of each other ± 2 mm in any direction, closed position adjustable. Assembly without side seal possible with altered glass processing.	1/2
8392ZNPVD36-L	Schwarz glänzend Gloss black				

MADE
IN
GERMANY

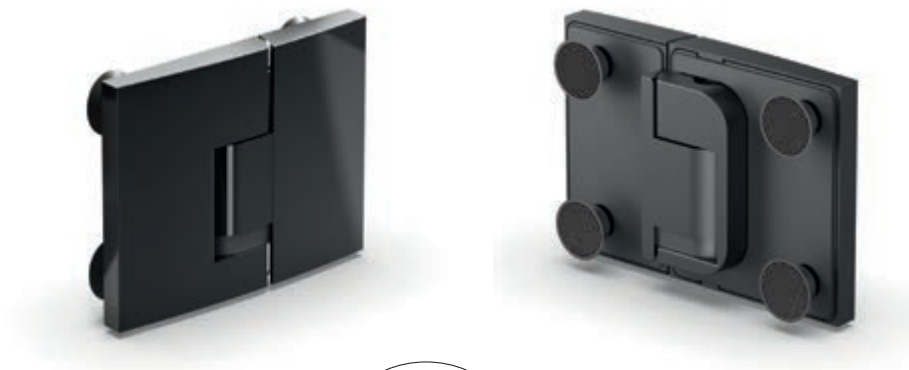

Glasbearbeitung für 8 mm
ohne Dichtprofil
glass processing for 8 mm
without sealing profile

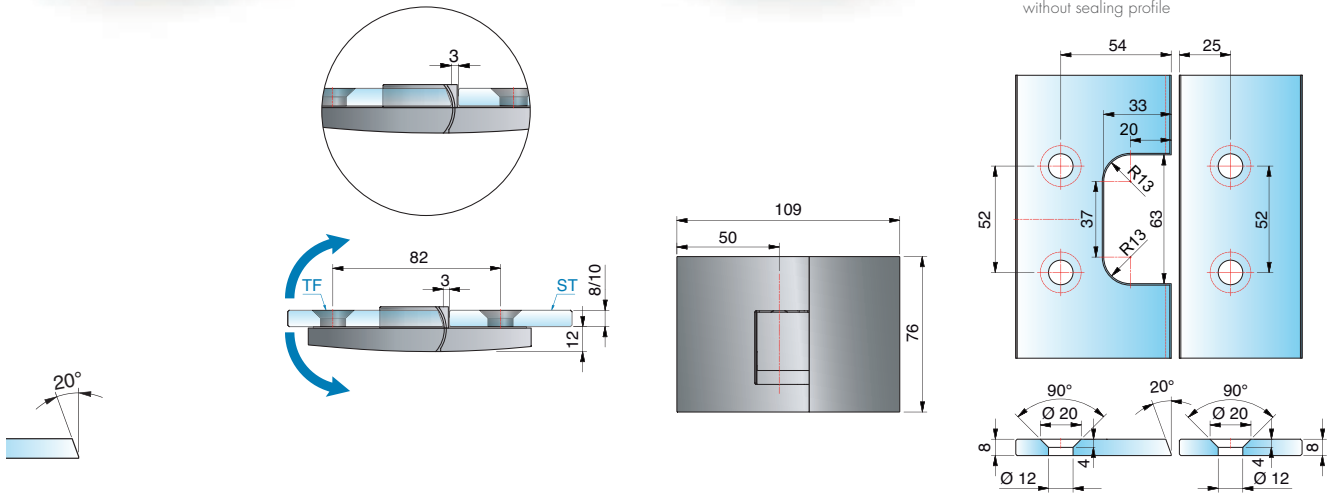

Glasbearbeitung für 8 mm
mit Dichtprofil 8845KU0-8K-2500
glass processing for 8 mm with
sealing profile 8845KU0-8K-2500

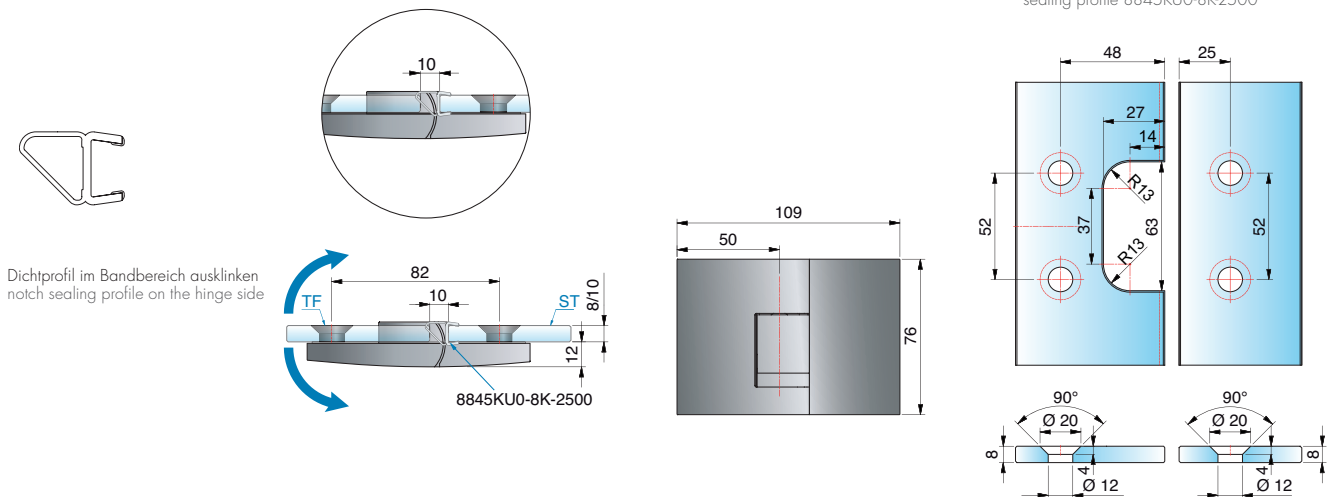

**Black
EDITION**

Art.-Nr. Art.-no.	Oberfläche Finish	Glasdicke Glass thickness	Artikelbezeichnung Article name	Merkmale Features	VE/Stück Pu/pieces
8392ZNPVD35-R	Schwarz matt Matt black	8/10 mm	Pendeltürband – PAVONE Glas-Wand 180°, rechts montiert, beidseitig öffnend PAVONE – Shower swing door hinge glass-wall 180°, Mounted on the right, opening in both directions	Glasbefestigung flächenbündig, Punkthalter unabhängig voneinander ± 2 mm in jede Richtung verstellbar, Nulllage einstellbar. Verbauung ohne Dichtung durch geänderte Glasbearbeitung möglich. glass fixtures flush, point fixture assembly adjustable independent of each other ± 2 mm in any direction, closed position adjustable. Assembly without side seal possible with altered glass processing.	1/2
8392ZNPVD36-R	Schwarz glänzend Gloss black				

MADE
IN
GERMANY

Winkelverbinder- PAVONE

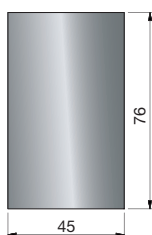
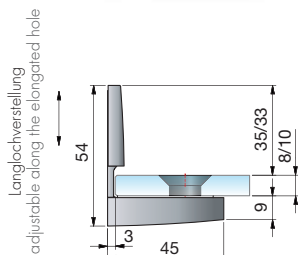

Glasbearbeitung für 8 mm
glass processing for 8 mm

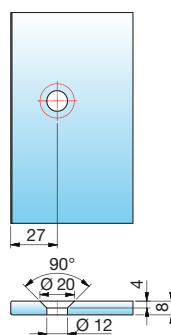

**Black
EDITION**

Art.-Nr. Art.-no.	Oberfläche Finish	Glasdicke Glass thickness	Artikelbezeichnung Article name	Merkmale Features	VE/Stück Pu/pieces
8398ZNPVD35	Schwarz matt Matt black	8/10 mm	PAVONE – Winkelverbinder Glas-Wand 90° PAVONE – Corner bracket glass-wall, 90°	Glasbefestigung flächenbündig, Lasche innen mit Langlochverstellung, Abdeckkappe, Punkthalter ± 2 mm in jede Richtung verstellbar glass mount flush, bracket inside with long hole adjustment, cover cap, point fixtures adjustable ± 2mm in any direction	1/2
8398ZNPVD36	Schwarz glänzend Gloss black				



Glasbearbeitung für 8 mm
glass processing for 8 mm

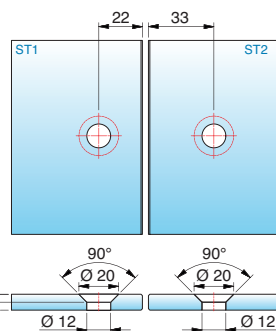
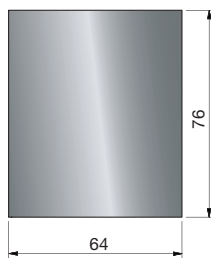
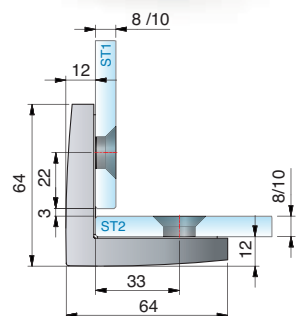

**Black
EDITION**

Art.-Nr. Art.-no.	Oberfläche Finish	Glasdicke Glass thickness	Artikelbezeichnung Article name	Merkmale Features	VE/Stück Pu/pieces
8399ZNPVD35	Schwarz matt Matt black	8/10 mm	PAVONE – Winkelverbinder Glas-Glas 90° PAVONE – Corner bracket glass-glass, 90°	Glasbefestigung flächenbündig, Abdeckkappe, Punkthalter ± 2 mm in jede Richtung verstellbar glass mount flush, cover cap, point fixtures adjustable ± 2mm in any direction	1/2
8399ZNPVD36	Schwarz glänzend Gloss black				





FLAMEA+

Die Serie FLAMEA+ wurde für Duschen der Top-Klasse entwickelt. Die optimale Einbausituation: Ganzglasduschen in XL-Formate FLAMEA+ erfüllt alle ästhetischen und funktionalen Ansprüche für den Objekt- und Privatbereich.

The FLAMEA+ series was developed for showers of Top Class. The optimum installation situation: Glass showers in XL-format. FLAMEA+ meets all aesthetic and functional requirements for projects and private homes.

- beidseitig 90° öffnendes Duschpendeltürband
- auf den letzten Zentimetern selbstschließend
- mittig liegender Drehpunkt und daher als Pendeltür nutzbar
- stufenlose Nulllageneinstellung
- Tragfähigkeit (2 Bänder): 45 kg entsprechen einer maximalen Türflügelgröße von 900 x 2000 mm bei 10 mm Glasdicke
- optimiert für die Verbauung ohne Dichtprofil
- keine sichtbare Verschraubung
- minimierte Spaltmaße und daher dichter
- die Haltbarkeit der Beschläge wurde durch werksinterne Versuche nach DIN EN 14428:2015 5.5 geprüft.

- 90° double-sided shower swing door hinge
- with self-regulated closing during the last centimeters
- centered pivot-point, therefore usage as swing door
- infinitely variable closed position,
- loading capacity (2 hinges): 45 kg corresponding to a glass door with the dimension 900 x 2000 mm and a glass thickness of 10 mm
- optimized for installation without sealing profile
- concealed screws
- minimized gap distance
- the durability of the hardware has been tested internally in accordance with DIN EN 14428:2015 5.5.



Duschtürband – FLAMEA+ | Shower door hinge – FLAMEA+



Schwarz matt
Matt black



Schwarz glänzend
Glass black

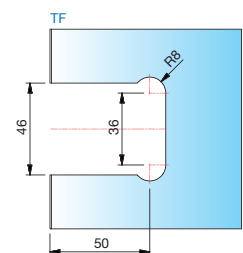
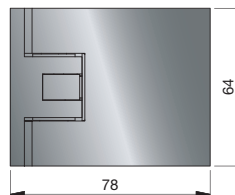
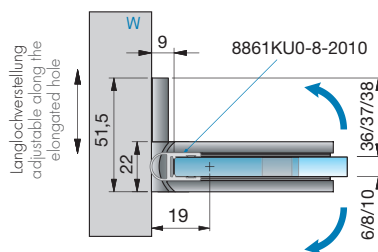
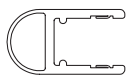
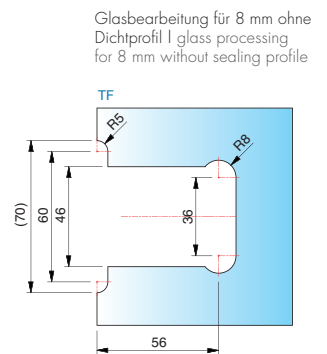
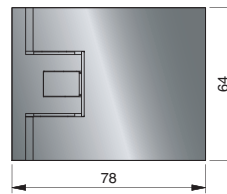
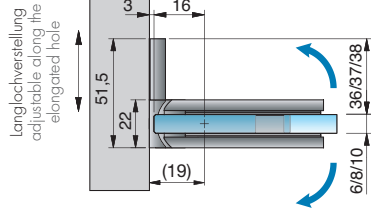
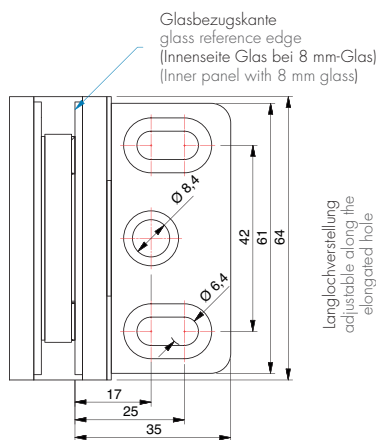

**Black
EDITION**

Art.-Nr. Art.-no.	Oberfläche Finish	Glasdicke Glass thickness	Artikelbezeichnung Article name	Merkmale Features	VE/Stück Pu/pieces
8130ZNPVD35	Schwarz matt Matt black	6/8/10 mm	Duschpendeltürband FLAMEA+ Glas-Wand 90°	beidseitig 90° öffnend, mit verstellbarer Nullagenstellung, Langlochverstellung, einseitige Befestigungsglasche verdeckte Verschraubung mit Abdeckkappe	1/2
8130ZNPVD36	Schwarz glänzend Gloss black	6/8/10 mm	shower swing door hinge FLAMEA+ glass-wall, 90°	double sided opening 90°, with adjustable closed position, adjustable within the notch, one sided mounting plate, concealed screws	<div style="display: flex; align-items: center;"> <div style="width: 10px; height: 10px; background-color: black; margin-right: 5px;"></div> <div style="width: 10px; height: 10px; background-color: red; margin-right: 5px;"></div> <div style="width: 10px; height: 10px; background-color: yellow; margin-right: 5px;"></div> <div style="margin-left: 5px;"> <p>MADE IN GERMANY</p> </div> </div>

Duschtürband – FLAMEA+



Schwarz matt
Matt black



Schwarz glänzend
Glass black

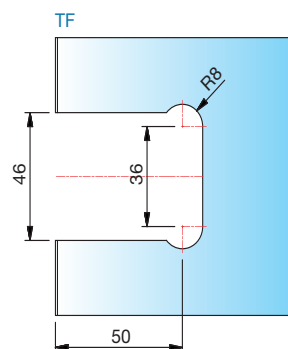
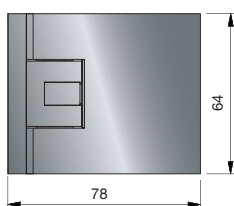
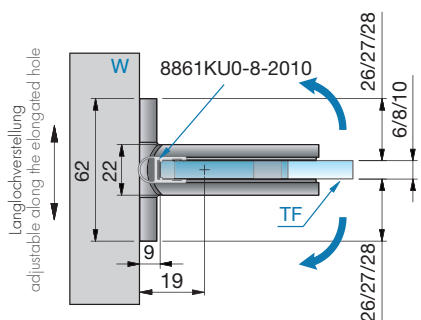
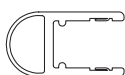
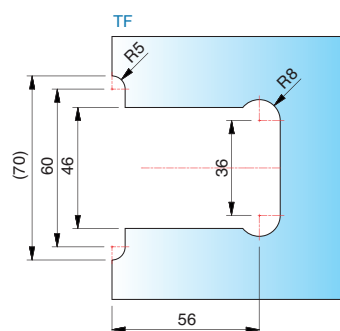
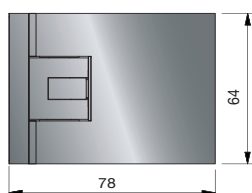
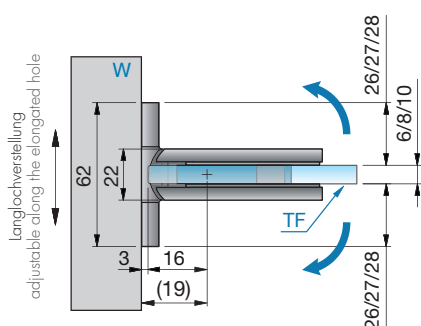
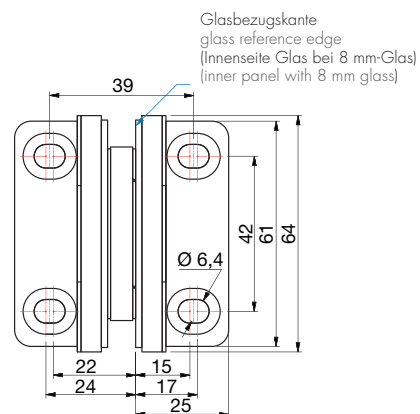

**Black
EDITION**

Art.-Nr. Art.-no.	Oberfläche Finish	Glasdicke Glass thickness	Artikelbezeichnung Article name	Merkmale Features	VE/Stück Pu/pieces
8134ZNPVD35	Schwarz matt Matt black	6/8/10 mm	Duschpendeltürband FLAMEA+ Glas-Wand 90°	beidseitig 90° öffnend, mit verstellbarer Nulllagenstellung, Langlochverstellung, beidseitige Befestigungslasche verdeckte Verschraubung mit Abdeckkappe	1/2
8134ZNPVD36	Schwarz glänzend Glass black		Shower swing door hinge FLAMEA+ glass-wall, 90°	double sided opening 90°, with adjustable closed position, adjustable within the notch, one sided mounting plate, concealed screws	

MADE
IN
GERMANY

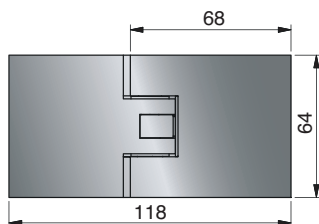
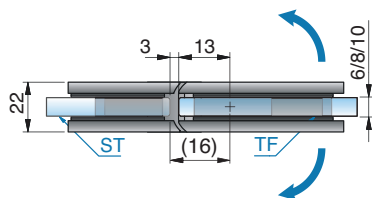

Glasbearbeitung für 8 mm ohne
Dichtprofil | glass processing
for 8 mm without sealing profile

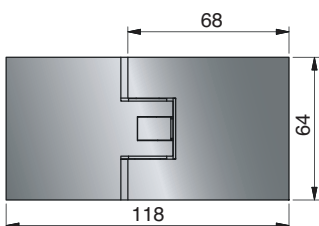
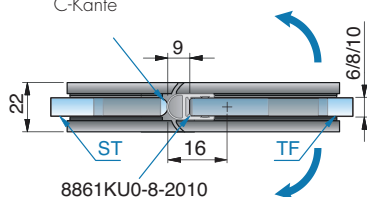
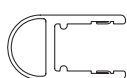
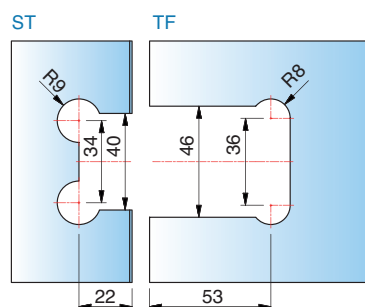

Glasbearbeitung für 8 mm mit
Dichtprofil 8861KU0-8-2010
glass processing for 8 mm with
sealing profile 8861KU0-8-2010

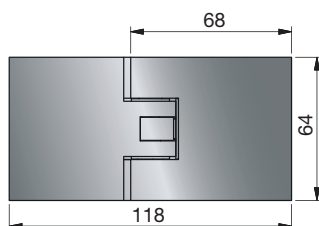
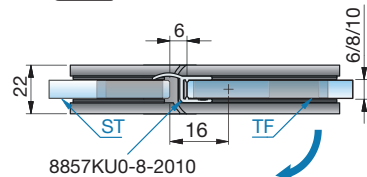
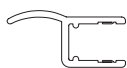
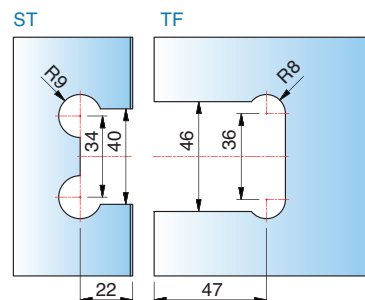

Glasbearbeitung für 8 mm mit
Dichtprofil 8857KU0-8-2010
glass processing for 8 mm with
sealing profile 8857KU0-8-2010

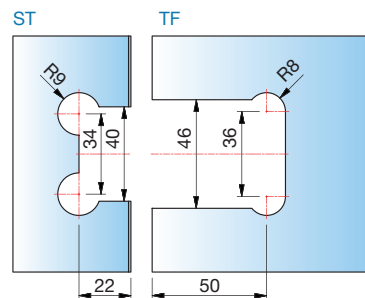

**Black
EDITION**

Art.-Nr. Art.-no.	Oberfläche Finish	Glasdicke Glass thickness	Artikelbezeichnung Article name	Merkmale Features	VE/Stück Pu/pieces
8132ZNPVD35	Schwarz matt Matt black	6/8/10 mm	Duschpendeltürband FLAMEA ⁺ Glas-Glas 180° shower swing door hinge FLAMEA ⁺ glass-glass, 180°	je nach Dichtung beidseitig 90° öffnend, mit verstellbarer Nullagenstellung, verdeckte Verschraubung mit Abdeckkappe opening in both directions 90° depending on sealing profile, with adjustable closed position, adjustable within the notch, concealed screws	1/2
8132ZNPVD36	Schwarz glänzend Gloss black				

MADE
IN
GERMANY

Duschtürband – FLAMEA+ | Shower door hinge – FLAMEA+



Schwarz matt
Matt black



Schwarz glänzend
Gloss black

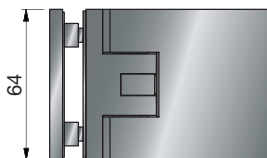
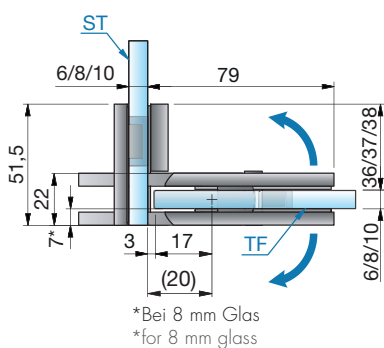

Glasbearbeitung für 8 mm ohne
Dichtprofil | glass processing
for 8 mm without sealing profile

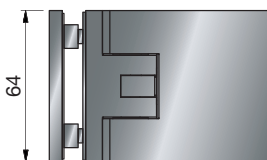
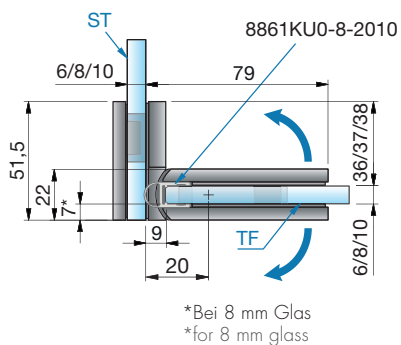
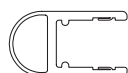
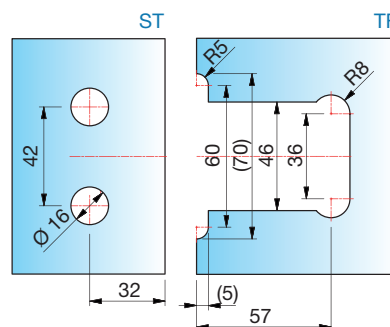

Glasbearbeitung für 8 mm mit
Dichtprofil 8861KU0-8-2010
glass processing for 8 mm with
sealing profile 8861KU0-8-2010

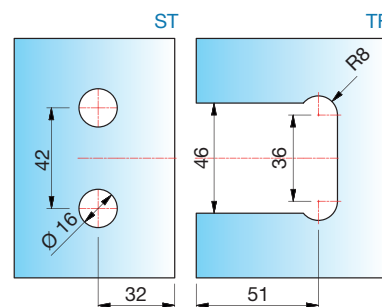

**Black
EDITION**

Art.-Nr. Art.-no.	Oberfläche Finish	Glasdicke Glass thickness	Artikelbezeichnung Article name	Merkmale Features	VE/Stück Pu/pieces
8136ZNPVD35	Schwarz matt Matt black	6/8/10 mm	Duschpendeltürband FLAMEA+ Glas-Glas 90° shower swing door hinge FLAMEA+ glass-glass, 90°	beidseitig 90° öffnend, mit verstellbarer Nulllagenstellung, verdeckte Verschraubung mit Abdeckkappe double sided opening 90°, with adjustable closed position, concealed screws	1/2
8136ZNPVD36	Schwarz glänzend Gloss black				

MADE
IN
GERMANY

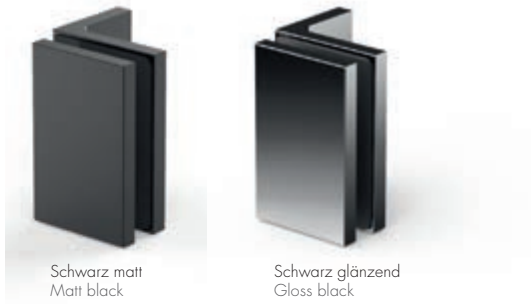

Schwarz matt
Matt black

Schwarz glänzend
Gloss black

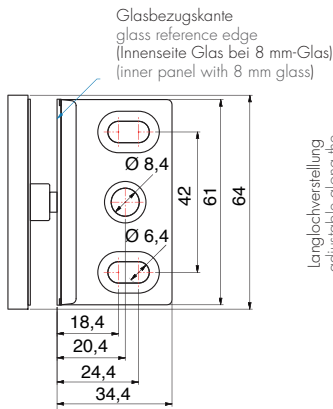

Langlochverstellung
adjustable along the
elongated hole

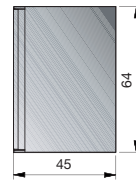
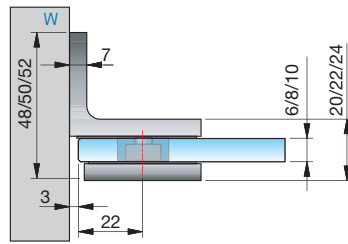

Glasbearbeitung für 6/8/10 mm
glass processing for 6/8/10 mm

Bohrung Ø 20 mm oder Randausschnitt R35
hole Ø 20 mm or cutout R35

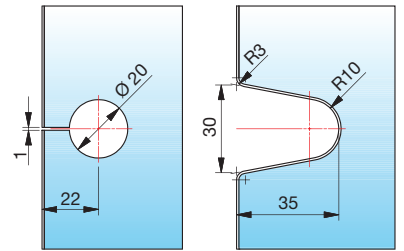

**Black
EDITION**

Art.-Nr. Art.-no.	Oberfläche Finish	Glasdicke Glass thickness	Artikelbezeichnung Article name	Merkmale Features	VE/Stück Pu/pieces
8194ZNPVD35	Schwarz matt Matt black	6/8/10 mm	Winkelverbinder FLAMEA ⁺ Glas-Wand 90° corner bracket FLAMEA ⁺ glass-wall, 90°	Wandbefestigung mit Langlochverstellung, verdeckte Verschraubung mit Abdeckkappe adjustable within the notch, concealed screws	1/2
8194ZNPVD36	Schwarz glänzend Gloss black				

MADE
IN
GERMANY



Schwarz matt
Matt black

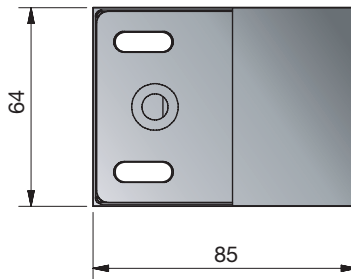
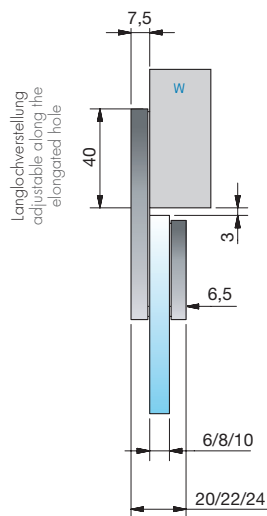

Glasbearbeitung für 6/8/10 mm
glass processing for 6/8/10 mm

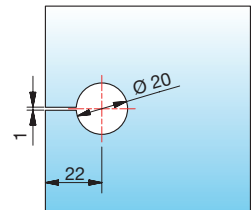

**Black
EDITION**

Art.-Nr. Art.-no.	Oberfläche Finish	Glasdicke Glass thickness	Artikelbezeichnung Article name	Merkmale Features	VE/Stück Pu/pieces
8193ZNPVD35	Schwarz matt Matt black	6/8/10 mm	Längsverbinder FLAMEA ⁺ Glas-Wand 180° corner bracket FLAMEA ⁺ glass-wall 180°	Wandbefestigung mit Langlochverstellung, verdeckte Verschraubung mit Abdeckkappe adjustable within the notch, concealed screws	1/2
8193ZNPVD36	Schwarz glänzend Gloss black				

MADE
IN
GERMANY

Winkelverbinder | Corner bracket



Schwarz matt
Matt black



Schwarz glänzend
Gloss black

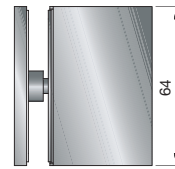
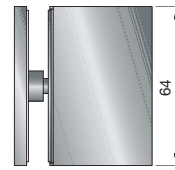
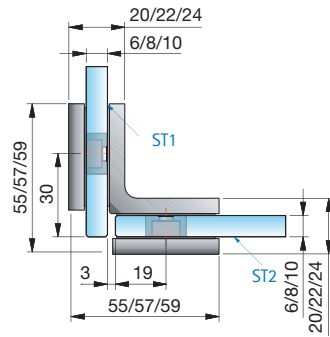
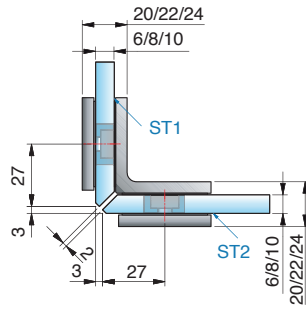

Glasbearbeitung für 8 mm
glass processing for 8 mm

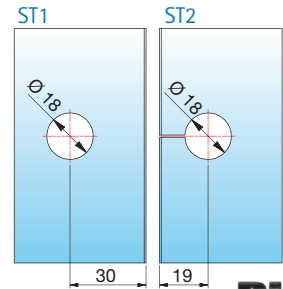
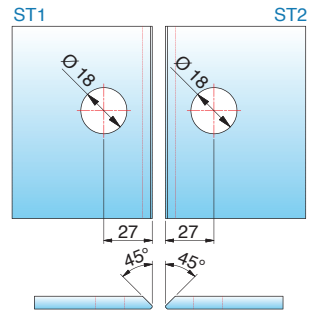

Black
EDITION

Art.-Nr. Art.-no.	Oberfläche Finish	Glasdicke Glass thickness	Artikelbezeichnung Article name	Merkmale Features	VE/Stück Pu/pieces
8196ZNPVD35	Schwarz matt Matt black	6/8/10 mm	Winkelverbinder FLAMEA+ Glas-Glas 90° corner bracket FLAMEA+ glass-glass, 90°	verdeckte Verschraubung mit Abdeckkappe concealed screws	1/2
8196ZNPVD36	Schwarz glänzend Gloss black				

MADE
IN
GERMANY



Schwarz matt
Matt black

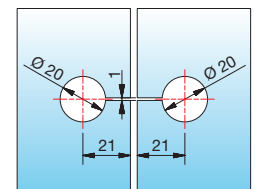
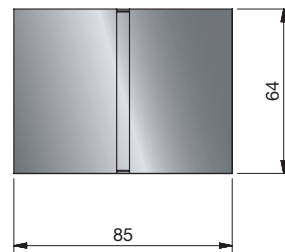
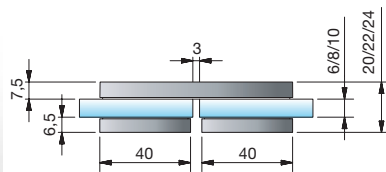

Glasbearbeitung für 6/8/10 mm
glass processing for 6/8/10 mm

Black
EDITION

Art.-Nr. Art.-no.	Oberfläche Finish	Glasdicke Glass thickness	Artikelbezeichnung Article name	Merkmale Features	VE/Stück Pu/pieces
8191ZNPVD35	Schwarz matt Matt black	6/8/10 mm	Längsverbinder FLAMEA+ Glas-Glas 180° corner bracket FLAMEA+ glass-glass, 180°	verdeckte Verschraubung mit Abdeckkappe concealed screws	1/2
8191ZNPVD36	Schwarz glänzend Gloss black				

MADE
IN
GERMANY



Glasbearbeitung für 8 mm

glass processing for 8 mm glass

Bei anderen Gradzahlen ändert sich der Gehrungswinkel oder der Bohrungsabstand dementsprechend – siehe Tabelle.

with other angles the miter angle and/or hole distance is changing according to table.

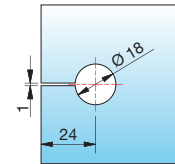
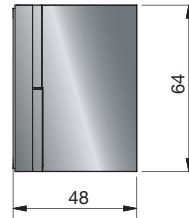
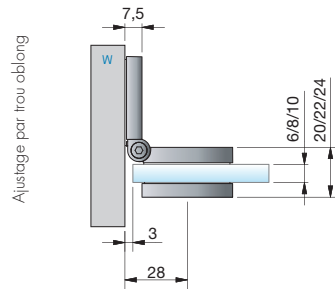

**Black
EDITION**

Art.-Nr. Art.-no.	Oberfläche Finish	Glasdicke Glass thickness	Artikelbezeichnung Article name	Merkmale Features	VE/Stück Pu/pieces
8199ZNPVD35	Schwarz matt Matt black	6/8/10 mm	Winkelverbinder FLAMEA+ Glas-Wand 90° corner bracket FLAMEA+ glass-wall, 90°	stufenlos von 60° - 100° verstellbar, verdeckte Verschraubung mit Abdeckkappe degree of angle is infinitely adjustable between 60° and 100°, concealed screws	1/2
8199ZNPVD36	Schwarz glänzend Gloss black				

MADE
IN
GERMANY

Gehrungswinkel und Bohrlochmaße für 8199ZN miter angle and hole dimensions for 8199ZN			
Winkel corner	Bohrlochmaß von Glaskante hole dimensions from glass edge	Gehrungswinkel am Glas miter angle	Bemerkung remarks
60°	33 mm	30°	-
65°	31 mm	25°	-
70°	30 mm	20°	-
75°	28 mm	15°	-
80°	27 mm	10°	-
85°	26 mm	5°	-
90°	24 mm	ohne Gehrung without miter angle	Bohrung geschlitzt hole slotted
95°	23 mm	5°	Bohrung geschlitzt hole slotted
100°	22 mm	10°	Bohrung geschlitzt hole slotted



Winkelverbinder | Corner bracket

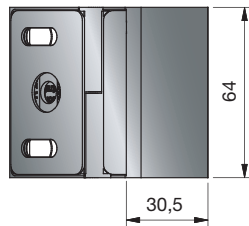
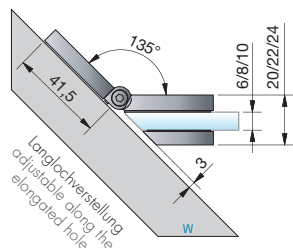

Glasbearbeitung für 8 mm

glass processing for 8 mm
glass

Bei anderen Gradzahlen
ändert sich der Gehrungswin-
kel oder der Bohrungsabstand
dementsprechend laut Tabelle.

with other angles the miter
angle and/or hole distance is
changing according to table.

Randausschnitt R30
edge recess R35

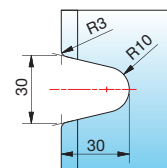

Bohrlochmaß bei 100°
hole dimensions with 100°

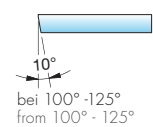
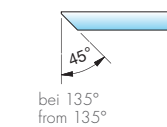
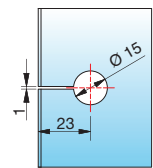

**Black
EDITION**

Art.-Nr. Art.-no.	Oberfläche Finish	Glasdicke Glass thickness	Artikelbezeichnung Article name	Merkmale Features	VE/Stück Pu/pieces
8189ZNPVD35	Schwarz matt Matt black	6/8/10 mm	Längsverbinder FLAMEA+ Glas-Glas 180° corner bracket FLAMEA+ glass-glass, 180°	verdeckte Verschraubung mit Abdeckkappe concealed screws	1/2
8189ZNPVD36	Schwarz glänzend Gloss black				

MADE
IN
GERMANY

Gehrungswinkel und Bohrlochmaße für 8189ZN miter angle and hole dimensions for 8189ZN			
Winkel corner	Bohrlochmaß von Glaskante hole dimensions from glass edge	Gehrungswinkel am Glas miter angle	Bemerkung remarks
100°	23 mm	10°	Bohrung geschlitzt hole slotted
105°	23 mm	15°	Bohrung geschlitzt hole slotted
110°	22 mm	20°	Bohrung geschlitzt hole slotted
115°	22 mm	25°	Bohrung geschlitzt hole slotted
120°	21 mm	30°	Bohrung geschlitzt hole slotted
125°	21 mm	35°	Bohrung geschlitzt hole slotted
130°	–	40°	Bohrung geschlitzt hole slotted
135°	–	45°	Bohrung geschlitzt hole slotted

Winkelverbinder | Corner bracket

Glasbearbeitung für 8 mm

glass processing for 8 mm glass

Bei anderen Gradzahlen ändert sich der Gehrungswinkel oder der Bohrungsabstand dementsprechend laut Tabelle.

with other angles the miter angle and/or hole distance is changing according to table.

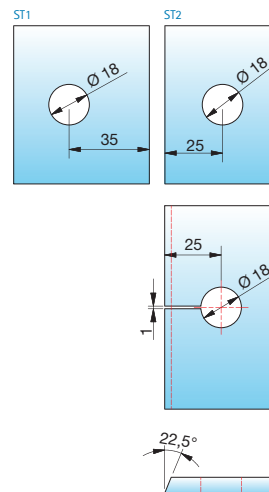
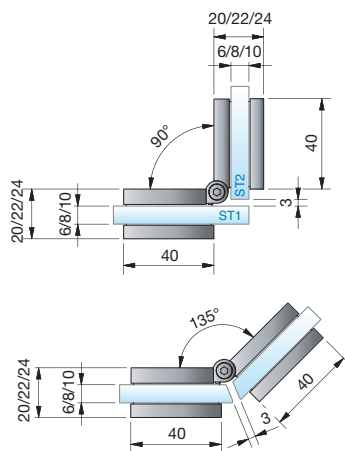

**Black
EDITION**

Art.-Nr. Art.-no.	Oberfläche Finish	Glasdicke Glass thickness	Artikelbezeichnung Article name	Merkmale Features	VE/Stück Pu/pieces
8198ZNPVD35	Schwarz matt Matt black	6/8/10 mm	Winkelverbinder FLAMEA+ Glas-Glas corner bracket FLAMEA+	stufenlos von 80° - 180° verstellbar verdeckte Verschraubung mit Abdeckkappe degree of angle is infinitely adjustable between 80° and 180°, concealed screws	1/2
8198ZNPVD36	Schwarz glänzend Gloss black				

MADE
IN
GERMANY

Gehrungswinkel und Bohrlochmaße für 8198ZN miter angle and hole dimensions for 8198ZN			
Winkel corner	Bohrlochmaß von Glaskante hole dimensions from glass edge	Gehrungswinkel am Glas miter angle	Bemerkung remarks
80°	36 mm	50°	-
85°	35 mm	47,5°	-
90°	33 mm	45°	-
95°	32 mm	42,5°	-
100°	31 mm	40°	Bohrung geschlitzt hole slotted
105°	30 mm	37,5°	Bohrung geschlitzt hole slotted
110°	29 mm	35°	Bohrung geschlitzt hole slotted
115°	28 mm	32,5°	Bohrung geschlitzt hole slotted
120°	28 mm	30°	Bohrung geschlitzt hole slotted
125°	27 mm	27,5°	Bohrung geschlitzt hole slotted
130°	26 mm	25°	Bohrung geschlitzt hole slotted
135°	25 mm	22,5°	Bohrung geschlitzt hole slotted
140°	25 mm	20°	Bohrung geschlitzt hole slotted
145°	24 mm	17,5°	Bohrung geschlitzt hole slotted
150°	23 mm	15°	Bohrung geschlitzt hole slotted
155°	23 mm	12,5°	Bohrung geschlitzt hole slotted
160°	22 mm	10°	Bohrung geschlitzt hole slotted
165°	22 mm	7,5°	Bohrung geschlitzt hole slotted
170°	21 mm	5°	Bohrung geschlitzt hole slotted
175°	20 mm	0°	Bohrung geschlitzt hole slotted
180°	20 mm	0°	Bohrung geschlitzt hole slotted

Winkelverbinder | Corner bracket



Schwarz matt
Matt black

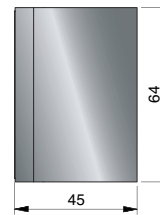
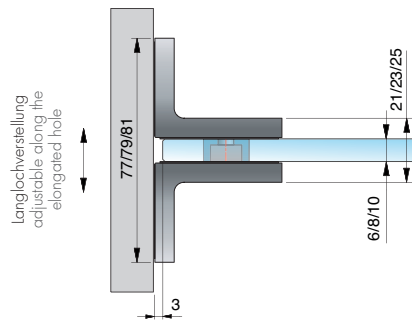

Glasbearbeitung für 6/8/10 mm
glass processing for 6/8/10 mm

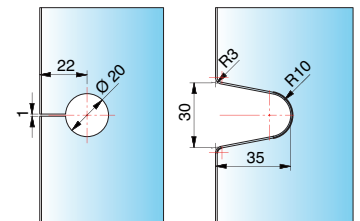

Black
EDITION

Art.-Nr. Art.-no.	Oberfläche Finish	Glasdicke Glass thickness	Artikelbezeichnung Article name	Merkmale Features	VE/Stück Pu/pieces
8195ZNPVD35	Schwarz matt Matt black	6/8/10 mm	zweiseitiger Winkelverbinder FLAMEA+ Wand-Glas-Wand 90° corner bracket FLAMEA+ wall-glass-wall 90°	beidseitige Befestigungslasche verdeckte Verschraubung mit Abdeckkappe double-sided fastening brackets concealed screws	1/2
8195ZNPVD36	Schwarz glänzend Gloss black				

MADE
IN
GERMANY



Schwarz matt
Matt black

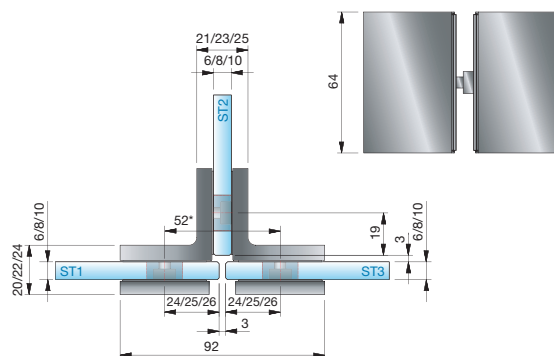

Glasbearbeitung für 8 mm
glass processing for 8 mm

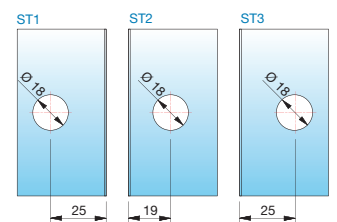

Black
EDITION

Art.-Nr. Art.-no.	Oberfläche Finish	Glasdicke Glass thickness	Artikelbezeichnung Article name	Merkmale Features	VE/Stück Pu/pieces
8197ZNPVD35	Schwarz matt Matt black	6/8/10 mm	zweiseitiger Winkelverbinder FLAMEA+ Glas-Glas 90° corner bracket FLAMEA+ glass-glass 90°	verdeckte Verschraubung mit Abdeckkappe concealed screws	1/2
8197ZNPVD36	Schwarz glänzend Gloss black				

MADE
IN
GERMANY





FLAMEA+ -SN

**Black
EDITION**

Mit dem Saunabeschlag FLAMEA+ -SN von Pauli + Sohn lassen sich individuelle Wellness-Oasen planen – von der kleinen Privatsauna bis hin zur großzügigen Saunalandschaft. Werkseigene Tests bestätigen die optimale Funktionalität bei Einhaltung der vorgeschriebenen Türmaße und deren Gewichte sowie der maximal zulässigen Umgebungstemperatur von 100° C.

With the sauna fitting FLAMEA+ -SN from Pauli + Sohn individual wellness oases can be planned - from small private saunas up to the spacious sauna landscapes. In-house tests confirm optimal functionality when the prescribed door dimensions and their weights are observed and the maximum permissible ambient temperature of 100 ° C is not exceeded.

- beidseitig 90° öffnendes Sauna-Pendeltürband
- minimierte Spaltmaße für den Einsatz im Saunabereich
- auf den letzten Zentimetern selbstschließend
- mittig liegender Drehpunkt und daher als Pendeltür nutzbar
- stufenlose Nulllageneinstellung
- hervorragende Qualität – “made in Germany” – Bei der Produktion der Saunabeschläge werden Materialien eingesetzt, welche diesen speziellen Anforderungen entsprechen und standhalten.

- 90° double sided shower swing door hinge
- minimized gap distances for the installation in a sauna
- automated closing during the last centimeters
- centered pivot-point, therefore usage as swing door
- infinitely adjustable closed position
- concealed screws



Sauna-Pendeltürband - FLAMEA+ | Sauna swing door hinge - FLAMEA+



Schwarz matt
Matt black



Schwarz glänzend
Gloss black

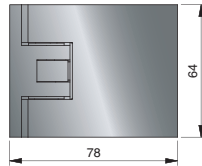
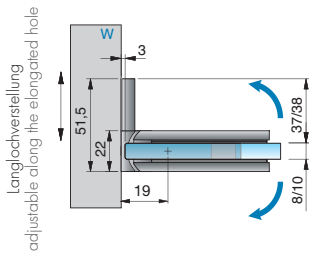

Glasbearbeitungen für die unterschiedlichen Spaltmaße
glass processing for different gap dimensions

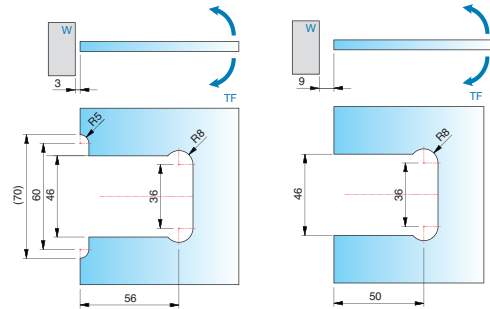

Black
EDITION

Art.-Nr. Art.-no.	Oberfläche Finish	Glasdicke Glass thickness	Artikelbezeichnung Article name	Merkmale Features	VE/Stück Pu/pieces
8130ZNPVD35-SN	Schwarz matt Matt black	8/10 mm	Sauna-Pendeltürband FLAMEA+, Glas-Wand 90°, max. Türbreite 800 mm, Tragfähigkeit (2 Bänder): 32 kg bei max. 800 x 2000 x 8 mm	beidseitig 90° öffnend, mit verstellbarer Nullagenstellung, Langlochverstellung, einseitige Befestigungslasche, verdeckte Verschraubung mit Abdeckkappe	1/2
8130ZNPVD36-SN	Schwarz glänzend Gloss black		sauna swing door hinge FLAMEA+, glass-wall 90°, max. door width 800 mm Load capacity (2 hinges): 32 kg at max. 800 x 2000 x 8 mm	double sided opening 90°, with adjustable closed position, adjustable within the notch, one sided mounting plate, concealed screws	

MADE
IN
GERMANY



Schwarz matt
Matt black



Schwarz glänzend
Gloss black

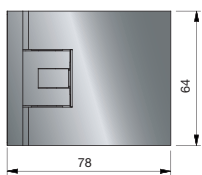
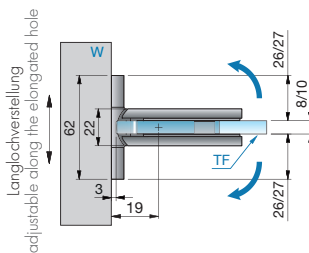

Glasbearbeitungen für die unterschiedlichen Spaltmaße
glass processing for different gap dimensions

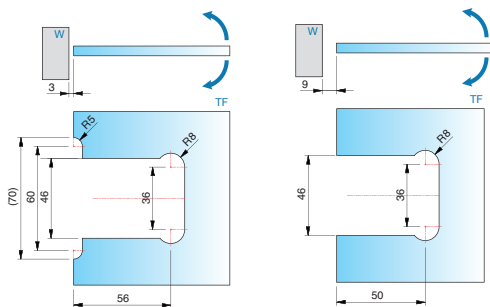

Black
EDITION

Art.-Nr. Art.-no.	Oberfläche Finish	Glasdicke Glass thickness	Artikelbezeichnung Article name	Merkmale Features	VE/Stück Pu/pieces
8134ZNPVD35-SN	Schwarz matt Matt black	8/10 mm	Sauna-Pendeltürband FLAMEA+, Glas-Wand 90°, max. Türbreite 900 mm, Tragfähigkeit (2 Bänder): 36 kg bei max. 900 x 2000 x 8 mm	beidseitig 90° öffnend, mit verstellbarer Nullagenstellung, Langlochverstellung, beidseitige Befestigungslasche, verdeckte Verschraubung mit Abdeckkappe	1/2
8134ZNPVD36-SN	Schwarz glänzend Gloss black		sauna swing door hinge FLAMEA+, glass-wall, 90°, max. door width 900 mm Load capacity (2 hinges): 36 kg at max. 900 x 2000 x 8 mm	double sided opening 90°, with adjustable closed position, adjustable within the notch, double sided mounting plate, concealed screws	

MADE
IN
GERMANY

Sauna-Pendeltürband - FLAMEA⁺ | Sauna swing door hinge - FLAMEA⁺

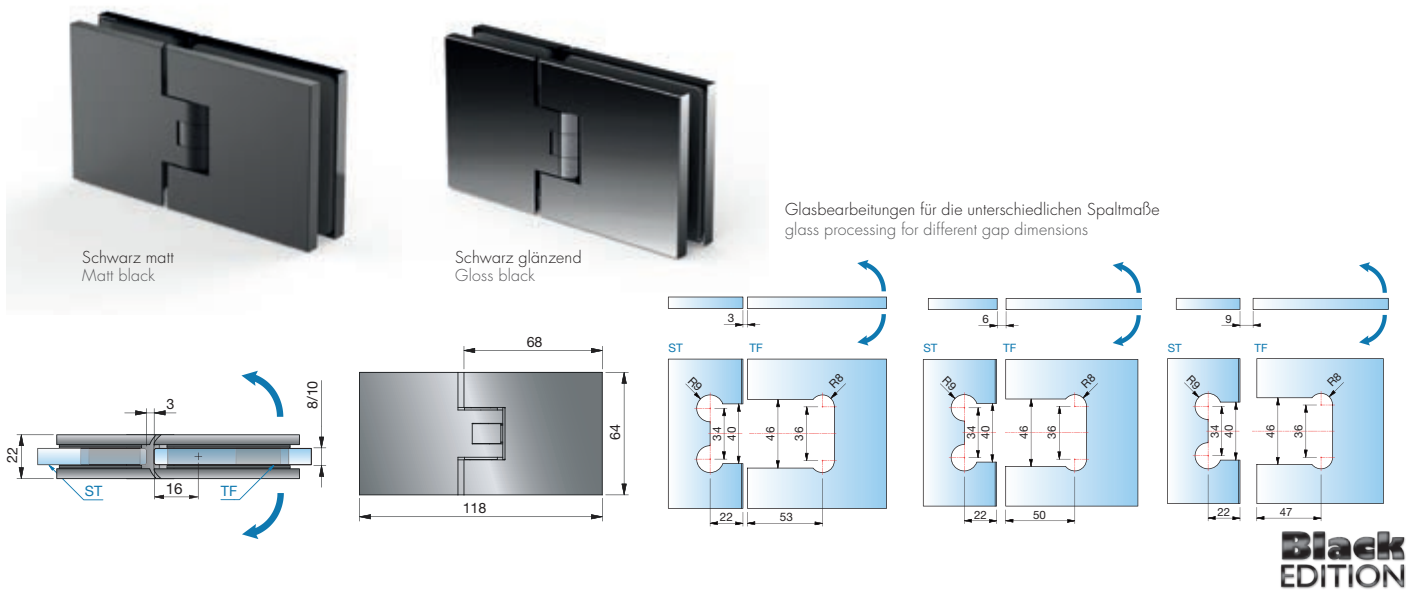

**Black
EDITION**

Art.-Nr. Art.-no.	Oberfläche Finish	Glasdicke Glass thickness	Artikelbezeichnung Article name	Merkmale Features	VE/Stück Pu/pieces
8132ZNPVD35-SN	Schwarz matt Matt black	8/10 mm	Sauna-Pendeltürband FLAMEA ⁺ , Glas-Glas 180°, max. Türbreite 750 mm, Tragfähigkeit (2 Bänder): 30 kg bei max. 750 x 2000 x 8 mm	je nach Dichtung beidseitig 90° öffnend, mit verstellbarer Nulllagenstellung, verdeckte Verschraubung mit Abdeckkappe double sided opening 90°, with adjustable closed position, adjustable within the notch, concealed screws	1/2
8132ZNPVD36-SN	Schwarz glänzend Gloss black		sauna swing door hinge FLAMEA ⁺ , glass-glass 180°, max. door width 750 mm Load capacity (2 hinges): 30 kg at max. 750 x 2000 x 8 mm		

MADE
IN
GERMANY

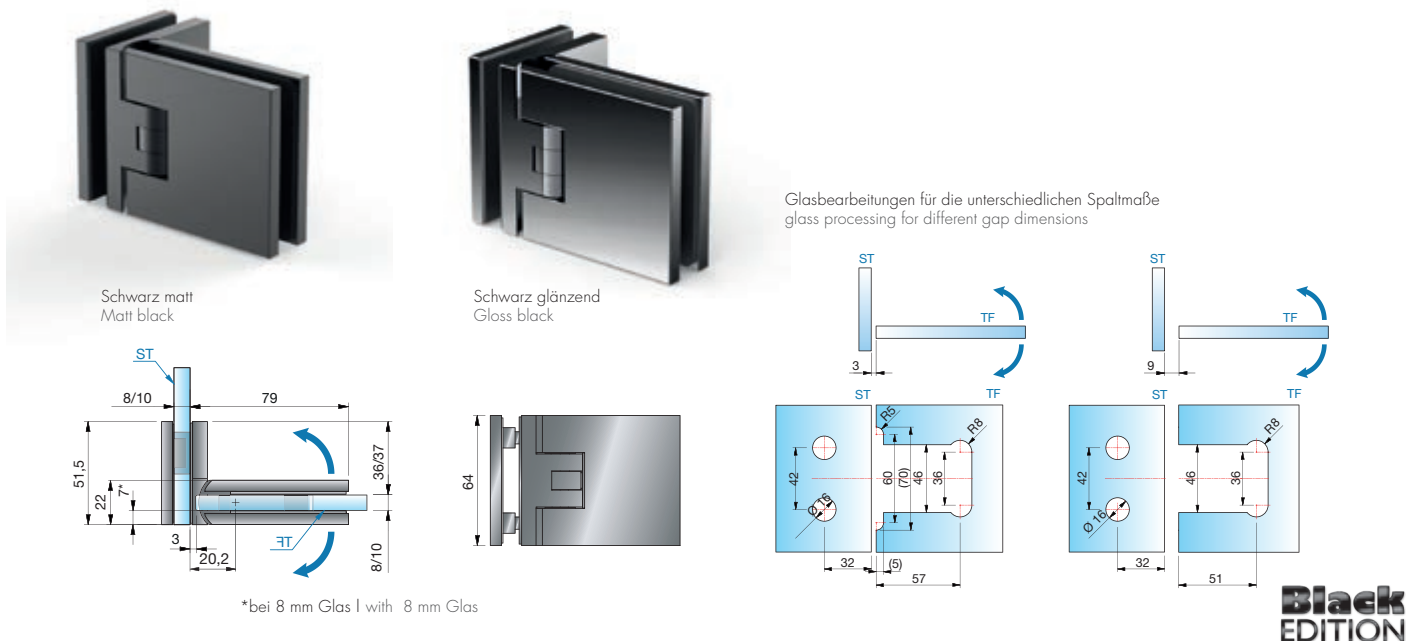

*bei 8 mm Glas | with 8 mm Glas

**Black
EDITION**

Art.-Nr. Art.-no.	Oberfläche Finish	Glasdicke Glass thickness	Artikelbezeichnung Article name	Merkmale Features	VE/Stück Pu/pieces
8136ZNPVD35-SN	Schwarz matt Matt black	8/10 mm	Sauna-Pendeltürband FLAMEA ⁺ , Glas-Glas 90°, max. Türbreite 800 mm, Tragfähigkeit (2 Bänder): 32 kg bei max. 800 x 2000 x 8 mm	beidseitig 90° öffnend, mit verstellbarer Nulllagenstellung, verdeckte Verschraubung mit Abdeckkappe double sided opening 90°, with adjustable closed position, concealed screws	1/2
8136ZNPVD36-SN	Schwarz glänzend Gloss black		sauna swing door hinge FLAMEA ⁺ , glass-glass 90°, max. door width 800 mm Load capacity (2 hinges): 32 kg at max. 800 x 2000 x 8 mm		

MADE
IN
GERMANY

Sauna-Winkelverbinder - FLAMEA+ | Sauna corner bracket FLAMEA+



Schwarz matt
Matt black



Schwarz glänzend
Gloss black

Langlochverstellung
adjustable along the elongated hole

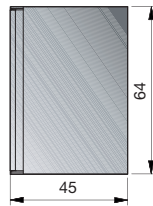
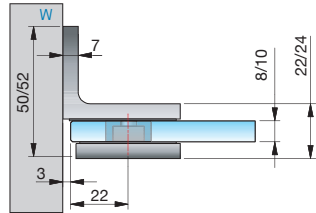

Glasbearbeitung für 6/8/10 mm
glass processing for 6/8/10 mm

Bohrung Ø 20 mm oder Randausschnitt R35
hole ø 20 mm or cutout R35

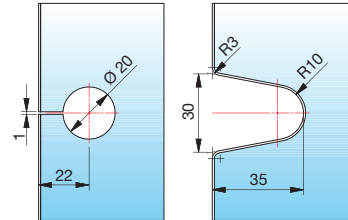

Black
EDITION

Art.-Nr. Art.-no.	Oberfläche Finish	Glasdicke Glass thickness	Artikelbezeichnung Article name	Merkmale Features	VE/Stück Pu/pieces
8194ZNPVD35-SN	Schwarz matt Matt black	6/8/10 mm	Sauna-Winkelverbinder FLAMEA+, Glas-Wand 90° sauna corner bracket FLAMEA+ glass-wall, 90°	Wandbefestigung mit Langlochverstellung, verdeckte Verschraubung mit Abdeckkappe adjustable within the notch, concealed screws	1/2
8194ZNPVD36-SN	Schwarz glänzend Gloss black				

MADE
IN
GERMANY



Schwarz matt
Matt black



Schwarz glänzend
Gloss black

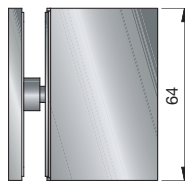
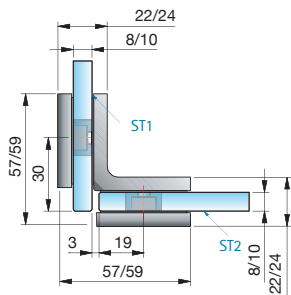

Glasbearbeitung für 8 mm
glass processing for 8 mm

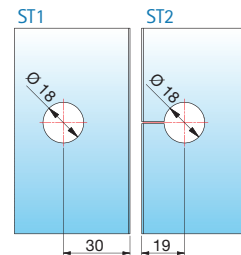

Black
EDITION

Art.-Nr. Art.-no.	Oberfläche Finish	Glasdicke Glass thickness	Artikelbezeichnung Article name	Merkmale Features	VE/Stück Pu/pieces
8196ZNPVD35-SN	Schwarz matt Matt black	6/8/10 mm	Sauna-Winkelverbinder FLAMEA+, Glas-Glas 90° sauna corner bracket FLAMEA+ glass-glass, 90°	verdeckte Verschraubung mit Abdeckkappe concealed screws	1/2
8196ZNPVD36-SN	Schwarz glänzend Gloss black				

MADE
IN
GERMANY



FARFALLA

**Black
EDITION**

FARFALLA ist ein Band von zuverlässiger Funktionalität und zeitlosem Erscheinungsbild. Das Anschlagtürband ohne definierte Nulllageneinstellung öffnet sich einseitig nach außen oder innen – in Kombination mit PONTERE lassen sich auch Falanlagen realisieren. Ein Duschband für den Objekt- und Privatbereich. Höchste Qualität zu einem marktgerechten Preis.

- verdeckte Verschraubung mit Abdeckkappe
- einseitig nach außen oder innen hin öffnendes Anschlagtürband
- Montage mit durchgehender Dichtung möglich
- alle Sets nach DIN EN 14428 geprüft
- Bandachse außerhalb der Glasflucht positioniert, deshalb ein komplettes Falten der Glaselemente möglich
- Glasdicke: 6, 8 und 10 mm
- Tragfähigkeit (2 Bänder): 40 kg entspricht einer maximalen Türflügelgröße von 1000 x 2000 mm bei 8 mm Glasdicke
- Die Haltbarkeit der Beschläge wurde durch werksinterne Versuche nach DIN EN 14428:2015 5.5 geprüft.

FARFALLA is a hinge with reliable functionality and timeless appearance. The striker hinge without a defined closed position opens either inwards or outwards. In combination with PONTERE, a folding installation can be realized. A shower hinge for projects or private homes. Highest quality at a fair market price.

- concealed screws
- door hinge opens outwards or inwards on one side
- assembling with continuous sealing profile possible
- all installations and sets are tested according to DIN EN 14428
- the hinge axis is positioned outside of the glass door so that the glass segments can also be folded completely
- Glass thickness: 6, 8 und 10 mm
- load capacity (2 hinges): 40 kg corresponding to a glass door of 1000 x 2000 mm with glass thickness of 8 mm
- The durability of the hardware has been tested internally in accordance with DIN EN 14428:2015 5.5.



Duschtürband – FARFALLA | Shower door hinge – FARFALLA



Schwarz matt
Matt black



Schwarz glänzend
Gloss black

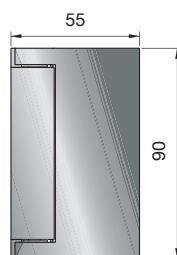
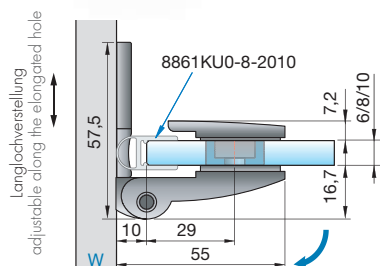

Glasbearbeitung für 8 mm
glass processing for 8 mm

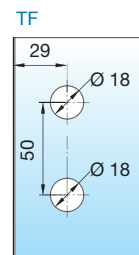

Black
EDITION

Art.-Nr. Art.-no.	Oberfläche Finish	Glasdicke Glass thickness	Artikelbezeichnung Article name	Merkmale Features	VE/Stück Pu/pieces
8128ZN35	RAL9005 Schwarz matt Matt black	6/8/10 mm	Duschtürband FARFALLA Glas-Wand 90° shower door hinge FARFALLA glass-wall, 90°	90° nach außen hin öffnend, Wandbefestigung mit Langlochverstellung und Abdeckplatte, durchgehende Dichtung, verdeckte Verschraubung mit Abdeckkappe	1/2
8128ZN36	RAL9005 Schwarz glänzend Gloss black			opening outwards 90°, wall mount adjustable with the notch, comes with cover plate, end-to-end sealing profile, concealed screws	

MADE
IN
GERMANY



Schwarz matt
Matt black



Schwarz glänzend
Gloss black

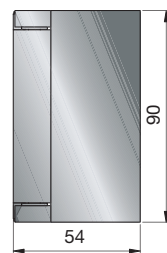
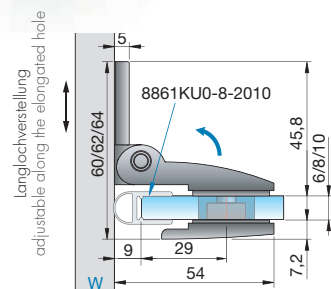

Glasbearbeitung für 8 mm
glass processing for 8 mm

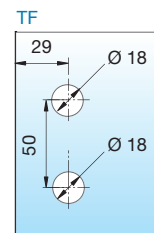

Black
EDITION

Art.-Nr. Art.-no.	Oberfläche Finish	Glasdicke Glass thickness	Artikelbezeichnung Article name	Merkmale Features	VE/Stück Pu/pieces
8120ZN35	RAL9005 Schwarz matt Matt black	6/8/10 mm	Duschtürband FARFALLA Glas-Wand 90° shower door hinge FARFALLA glass-wall, 90°	90° nach innen hin öffnend, Wandbefestigung mit Langlochverstellung und Abdeckplatte, durchgehende Dichtung, verdeckte Verschraubung mit Abdeckkappe	1/2
8120ZN36	RAL9005 Schwarz glänzend Gloss black			opening inward 90°, wall mount adjustable with the notch, comes with cover plate, end-to-end sealing profile, concealed screws	

MADE
IN
GERMANY

Duschtürband – FARFALLA | Shower door hinge – FARFALLA



Schwarz matt
Matt black



Schwarz glänzend
Gloss black

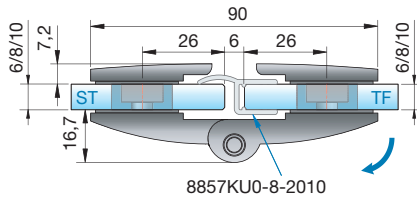

8857KU0-8-2010

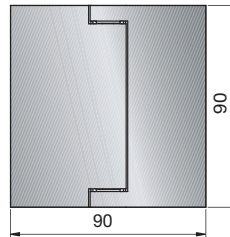

Glasbearbeitung für 8 mm
glass processing for 8 mm

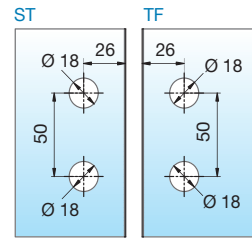

**Black
EDITION**

Art.-Nr. Art.-no.	Oberfläche Finish	Glasdicke Glass thickness	Artikelbezeichnung Article name	Merkmale Features	VE/Stück Pu/pieces
8122ZN35	RAL9005 Schwarz matt Matt black	6/8/10 mm	Duschtürband FARFALLA Glas-Glas 180° shower door hinge FARFALLA glass-glass, 180°	180° nach außen hin öffnend, durchgehende Dichtung, verdeckte Verschraubung mit Abdeckkappe opening outwards 180°, end-to-end sealing profile, concealed screws	1/2
8122ZN36	RAL9005 Schwarz glänzend Gloss black				

MADE
IN
GERMANY



Schwarz matt
Matt black

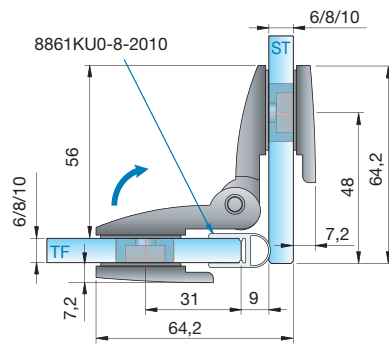

8861KU0-8-2010

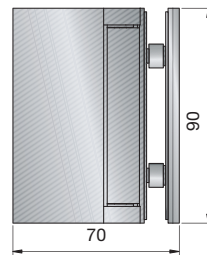

Glasbearbeitung für 8 mm
glass processing for 8 mm

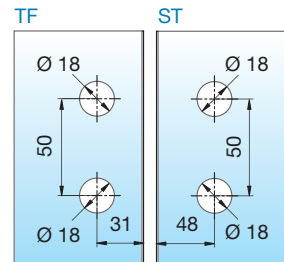

Schwarz glänzend
Gloss black

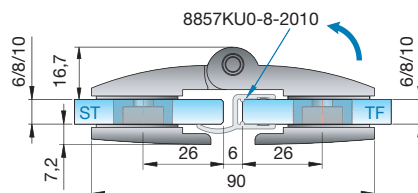

8857KU0-8-2010

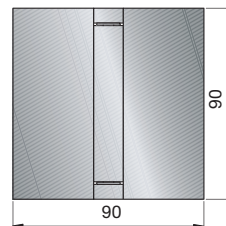

Glasbearbeitung für 8 mm
glass processing for 8 mm

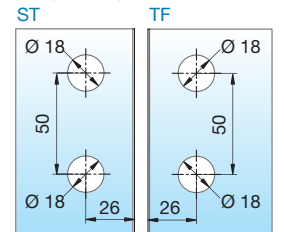

**Black
EDITION**

Art.-Nr. Art.-no.	Oberfläche Finish	Glasdicke Glass thickness	Artikelbezeichnung Article name	Merkmale Features	VE/Stück Pu/pieces
8124ZN35	RAL9005 Schwarz matt Matt black	6/8/10 mm	Duschtürband FARFALLA Glas-Glas 180° shower door hinge FARFALLA glass-glass, 180°	180° nach innen hin öffnend, durchgehende Dichtung, verdeckte Verschraubung mit Abdeckkappe opening inward 180°, end-to-end sealing profile, concealed screws	1/2
8124ZN36	RAL9005 Schwarz glänzend Gloss black				

MADE
IN
GERMANY



Schwarz matt
Matt black



Schwarz glänzend
Gloss black

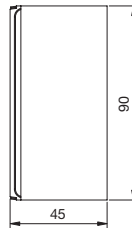
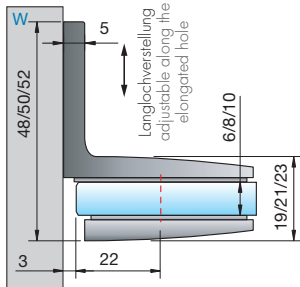

Glasbearbeitung für 8 mm
glass processing for 8 mm

Bohrung \varnothing 20 mm oder Randausschnitt R35
hole \varnothing 20 mm or cutout R35

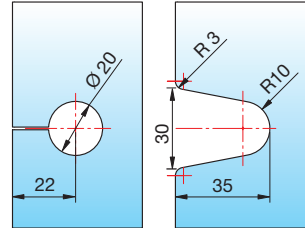

Black
EDITION

Art.-Nr. Art.-no.	Oberfläche Finish	Glasdicke Glass thickness	Artikelbezeichnung Article name	Merkmale Features	VE/Stück Pu/pieces
8107ZN35	RAL9005 Schwarz matt Matt black	6/8/10 mm	Winkelverbinder Glas-Wand 90° corner bracket, glass-wall, 90°	Wandbefestigung mit Langlochverstellung, starr verdeckte Verschraubung mit Abdeckkappe wall mount adjustable within the notch, concealed screws	1/2
8107ZN36	RAL9005 Schwarz glänzend Gloss black				

MADE
IN
GERMANY



Schwarz matt
Matt black



Schwarz glänzend
Gloss black

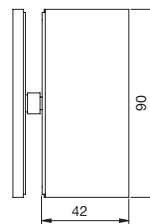
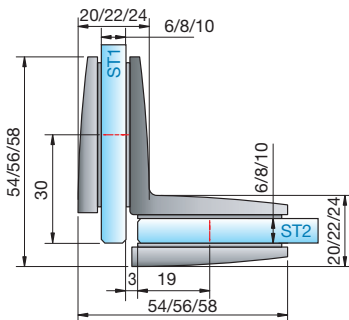

Glasbearbeitung für 8 mm
glass processing for 8 mm

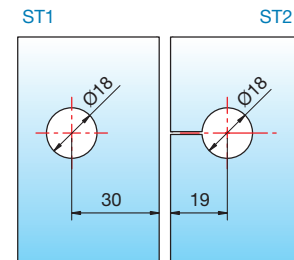

Black
EDITION

Art.-Nr. Art.-no.	Oberfläche Finish	Glasdicke Glass thickness	Artikelbezeichnung Article name	Merkmale Features	VE/Stück Pu/pieces
8109ZN35	RAL9005 Schwarz matt Matt black	6/8/10 mm	Winkelverbinder Glas-Glas 90° corner bracket, glass-glass, 90°	verdeckte Verschraubung mit Abdeckkappe concealed screws	1/2
8109ZND36	RAL9005 Schwarz glänzend Gloss black				

MADE
IN
GERMANY

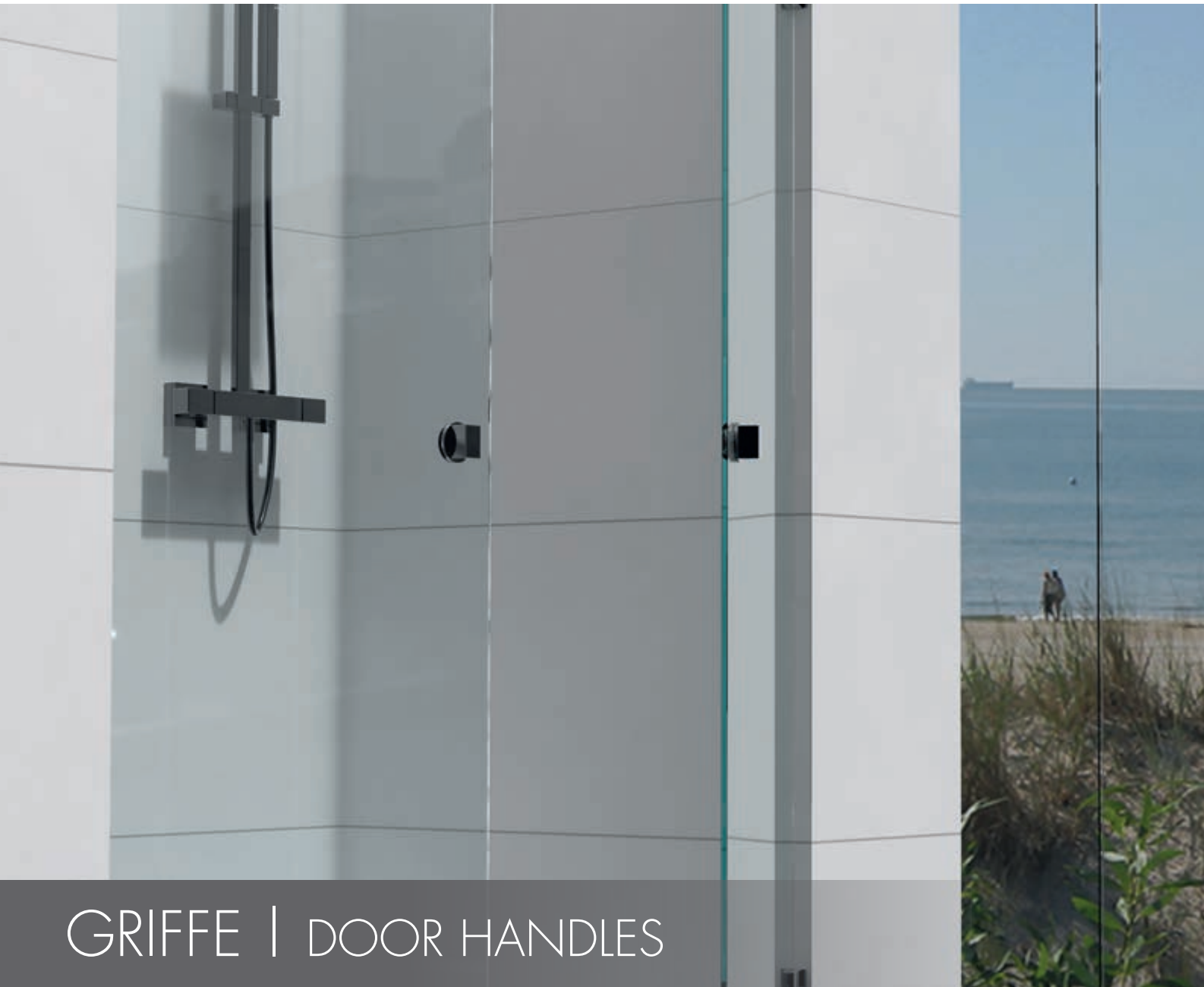

GRIFFE | DOOR HANDLES

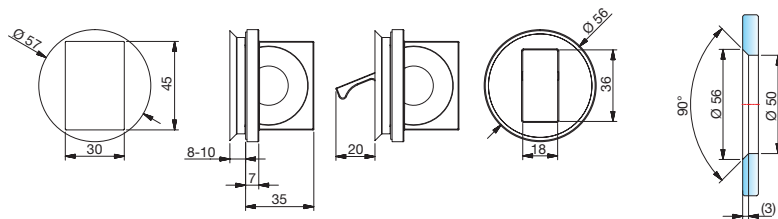

**Black
EDITION**

Art.-Nr. Art.-no.	Oberfläche Finish	Glasdicke Glass thickness	Artikelbezeichnung Article name	VE/Stück Pu/pieces
8379ZNPVD35	Schwarz matt Matt black	8-10 mm	Glastürgriff flächenbündig glass door handle flush	1/1
8379ZNPVD36	Schwarz glänzend Gloss black			

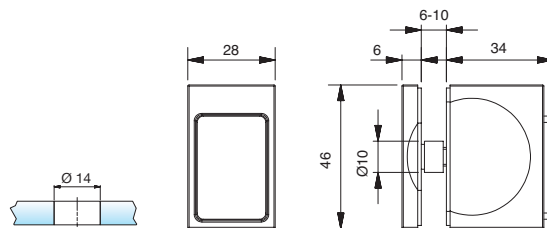

**Black
EDITION**

Art.-Nr. Art.-no.	Oberfläche Finish	Glasdicke Glass thickness	Artikelbezeichnung Article name	VE/Stück Pu/pieces
8271MSPVD35-A	Schwarz matt Matt black	6-10 mm	Glastürgriff einseitig mit Gummianschlag einseitig	1/1
8271MSPVD36-A	Schwarz glänzend Gloss black		glass door knob with rubber stop one sided	

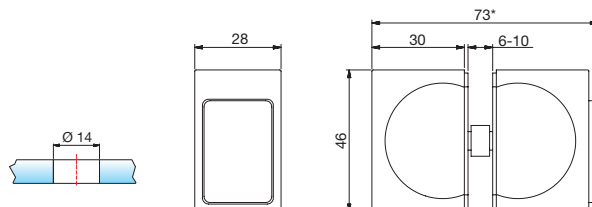

*Bei 8 mm Glas
*for 8 mm glass

**Black
EDITION**

Art.-Nr. Art.-no.	Oberfläche Finish	Glasdicke Glass thickness	Artikelbezeichnung Article name	VE/Stück Pu/pieces
8273MSPVD35-A	RAL9005 Schwarz Matt RAL9005 Matt black	6-10 mm	Glastürgriff beidseitig mit Gummianschlag einseitig	1/1
8273MSPVD36-A	RAL9005 Schwarz glänzend RAL9005 Gloss black		glass door knob double sided with rubber stop one sided	

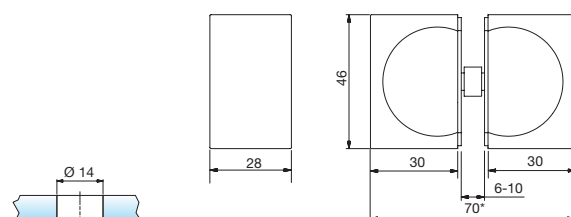

*Bei 8 mm Glas
*for 8 mm glass

**Black
EDITION**

Art.-Nr. Art.-no.	Oberfläche Finish	Glasdicke Glass thickness	Artikelbezeichnung Article name	VE/Stück Pu/pieces
8278MSPVD35-A	Schwarz matt Matt black	6-10 mm	Glastürgriff beidseitig ohne Logoeindruck	1/1
8278MSPVD36-A	Schwarz glänzend Gloss black		double sided glass door handle without logo	

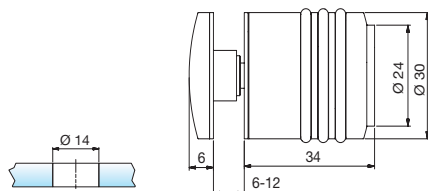

**Black
EDITION**

Art.-Nr. Art.-no.	Oberfläche Finish	Glasdicke Glass thickness	Artikelbezeichnung Article name	VE/Stück Pu/pieces
8293MSPVD35	Schwarz matt Matt black	6-12 mm	Glastürknopf einseitig mit Gummianschlag einseitig	1/1
8293MSPVD36	Schwarz glänzend Gloss black		glass door knob one sided, with rubber stop one sided	

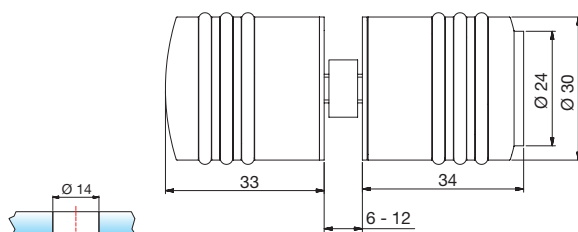

**Black
EDITION**

Art.-Nr. Art.-no.	Oberfläche Finish	Glasdicke Glass thickness	Artikelbezeichnung Article name	VE/Stück Pu/pieces
8294MSPVD35	Schwarz matt Matt black	6-12 mm	Glastürknopf beidseitig mit Gummianschlag einseitig	1/1
8294MSPVD36	Schwarz glänzend Gloss black		glass door knob double sided, with rubber stop one sided	

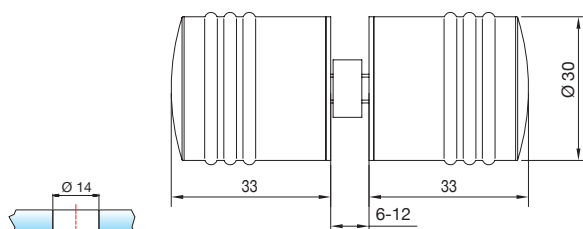
**Black
EDITION**

Art.-Nr. Art.-no.	Oberfläche Finish	Glasdicke Glass thickness	Artikelbezeichnung Article name	VE/Stück Pu/pieces
8298MS35	RAL9005 Schwarz Matt RAL9005 Matt black	6-12 mm	Glastürknopf beidseitig glass door handle double sided	1/1
8298MS36	RAL9005 Schwarz glänzend RAL9005 Gloss black			

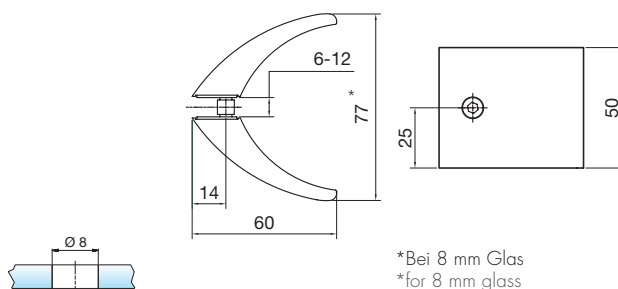
**Black
EDITION**

Art.-Nr. Art.-no.	Oberfläche Finish	Glasdicke Glass thickness	Artikelbezeichnung Article name	VE/Stück Pu/pieces
8297MSPVD35-50	Schwarz matt Matt black	6-12 mm	Glastürgriff beidseitig glass door handle double sided	1/1
8297MSPVD36-50	Schwarz glänzend Gloss black			
8297MS35-50	RAL9005 Schwarz matt RAL9005 Matt black			
8297MS36-50	RAL9005 Schwarz glänzend RAL9005 Gloss black			



*series Flamea+ suited for saunas

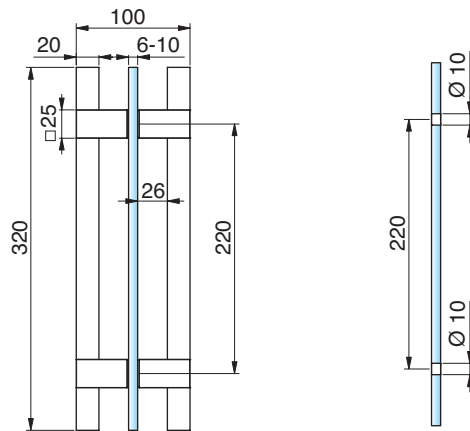

**Black
EDITION**

Art.-Nr. Art.-no.	Oberfläche Finish	Glasdicke Glass thickness	Artikelbezeichnung Article name	VE/Stück Pu/pieces
8373MSPVD35-HEM	Schwarz matt Matt black	6-10 mm	Glastürgriff beidseitig für Sauna-Anwendungen glass door handle double sided for sauna	1/1
8373MSPVD36-HEM	Schwarz glänzend Gloss black			

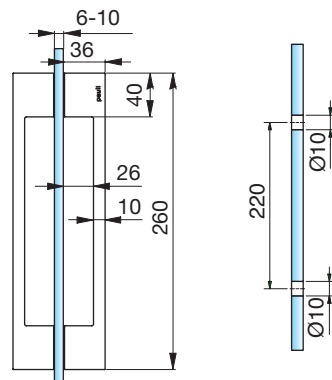

**Black
EDITION**

Art.-Nr. Art.-no.	Oberfläche Finish	Glasdicke Glass thickness	Artikelbezeichnung Article name	VE/Stück Pu/pieces
8277ZNPVD35-A	Schwarz matt Matt black	6-10 mm	Glastürgriff beidseitig ohne Logoeindruck glass door handle double sided without logo	1/1
8277ZNPVD36-A	Schwarz glänzend Gloss black			
8277ZN35-A	RAL9005 Schwarz matt RAL9005 Matt black			
8277ZN36-A	RAL9005 Schwarz glänzend RAL9005 Gloss black			

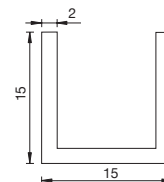
U-Profil
 U-profile

**Black
EDITION**

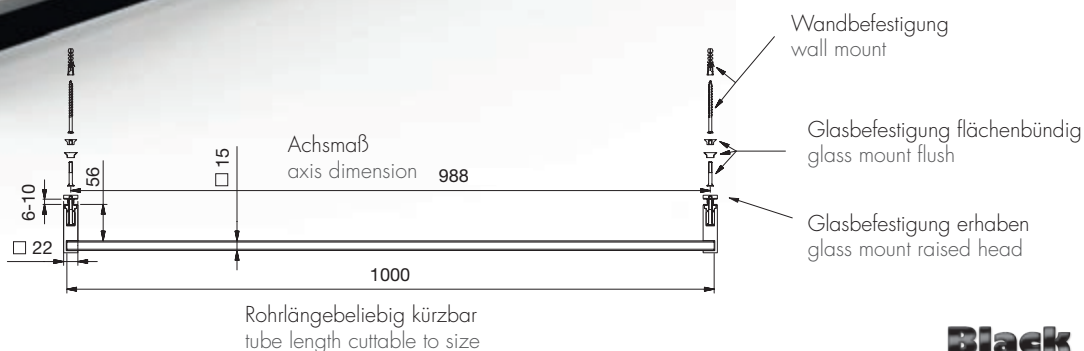
Art.-Nr. Art.-no.	Oberfläche Finish	Glasdicke Glass thickness	Artikelbezeichnung Article name	VE/Stück Pu/pieces
5015E6C35-5M	Aluminium schwarz eloxiert Aluminium black anodized	≤ 10 mm	U-Profil, 15x15x5000x2 mm U-profile, 15x15x5000x2 mm	1/1

 Handtuchhalter
 towel bar

**Black
EDITION**

Art.-Nr. Art.-no.	Oberfläche Finish	Glasdicke Glass thickness	Artikelbezeichnung Article name	VE/Stück Pu/pieces
8688MSPVD35-1000	Schwarz matt Matt black	6-10 mm	Handtuchhalter mit verschiedenen Befestigungen towel bar	1/1
8688MSPVD36-1000	Schwarz glänzend Gloss black			

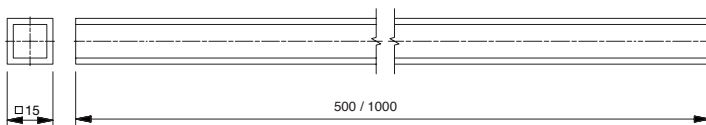

STABILISATIONSSYSTEME | SUPPORTING BARS

Rohrlängen beliebig kürzbar | tube length cuttable to size



**Black
EDITION**

Art.-Nr. Art.-no.	Oberfläche Finish	Länge length	Artikelbezeichnung Article name	VE/Stück Pu/pieces
8688-5MSPVD35-500	Schwarz matt Matt black	500 mm	Stabilisationsstange, Rohr supporting bar, tube	1/1
8688-5MSPVD36-1000	Schwarz glänzend Gloss black	1000 mm		
8688-5MSPVD35-500	Schwarz matt Matt black	500 mm		
8688-5MSPVD36-1000	Schwarz glänzend Gloss black	1000 mm		
8688-5AL35-500	RAL9005 Schwarz matt RAL9005 Matt black	500 mm		
8688-5AL35-1000	RAL9005 Schwarz matt RAL9005 Matt black	1000 mm		
8688-5AL35-1500	RAL9005 Schwarz matt RAL9005 Matt black	1500 mm		
8688-5AL35-2000	RAL9005 Schwarz matt RAL9005 Matt black	2000 mm		
8688-5AL36-500	RAL9005 Schwarz glänzend RAL9005 Gloss black	500 mm		
8688-5AL36-1000	RAL9005 Schwarz glänzend RAL9005 Gloss black	1000 mm		
8688-5AL36-1500	RAL9005 Schwarz glänzend RAL9005 Gloss black	1500 mm		
8688-5AL36-2000	RAL9005 Schwarz glänzend RAL9005 Gloss black	2000 mm		

für Rohr □ 15 mm | for tube □ 15 mm

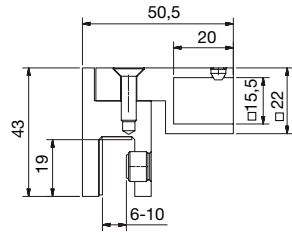

**Black
EDITION**

Art.-Nr. Article no.	Oberfläche Finish	Glasdicke Glass thickness	Artikelbezeichnung Article name	VE/Stück Pu/pieces
8494MSPVD35-G	Schwarz matt Matt black	6-10 mm	Glasanschluss für Stabilisationsstange glass adapter for supporting bar	1/1
8494MSPVD36-G	Schwarz glänzend Gloss black			
8494MS35-G	RAL9005 Schwarz matt RAL9005 Matt black			
8494MS36-G	RAL9005 Schwarz glänzend RAL9005 Gloss black			

für Rohr □ 15 mm | for tube □ 15 mm

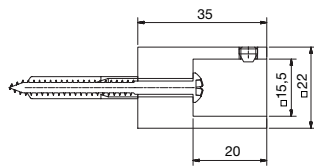
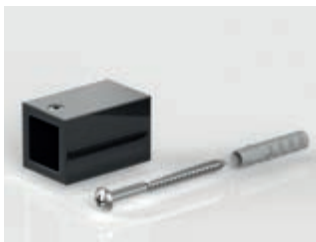

**Black
EDITION**

Art.-Nr. Article no.	Oberfläche Finish	Artikelbezeichnung Article name	VE/Stück Pu/pieces
8494MSPVD35-W	Schwarz matt Matt black	Wandanschluss 90° für Stabilisationsstange wall adapter 90° for supporting bar	1/1
8494MSPVD36-W	Schwarz glänzend Gloss black		
8494MS35-W	RAL9005 Schwarz matt RAL9005 Matt black		
8494MS36-W	RAL9005 Schwarz glänzend RAL9005 Gloss black		

für Rohr □ 15 mm | for tube □ 15 mm

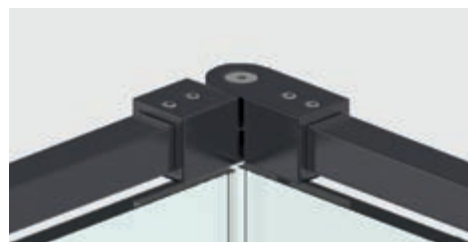
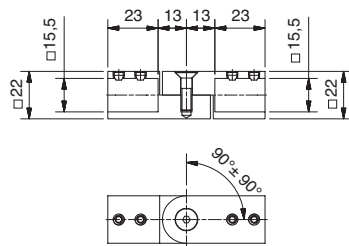

**Black
EDITION**

Art.-Nr. Article no.	Oberfläche Finish	Artikelbezeichnung Article name	VE/Stück Pu/pieces
8494MSPVD35-EV	Schwarz matt Matt black	Eckverbinder verstellbar 90-180° corner joint adjustable 90-180°	1/1
8494MSPVD36-EV	Schwarz glänzend Gloss black		

Black Edition – Stabilisationssysteme | Supporting bars

für Rohr □ 15 mm | for tube □ 15 mm

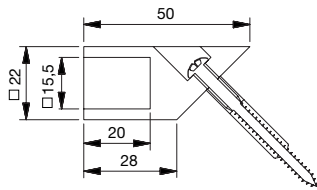

**Black
EDITION**

Art.-Nr. Article no.	Oberfläche Finish	Artikelbezeichnung Article name	VE/Stück Pu/pieces
8496MSPVD35-W45	Schwarz matt Matt black	Wandanschluss 45° für Stabilisationsstange wall adapter 45° for supporting bar	1/1
8496MSPVD36-W45	Schwarz glänzend Gloss black		
8496MS35-W45	RAL9005 Schwarz matt RAL9005 Matt black		
8496MS36-W45	RAL9005 Schwarz glänzend RAL9005 Gloss black		

für Rohr □ 15 mm | for tube □ 15 mm

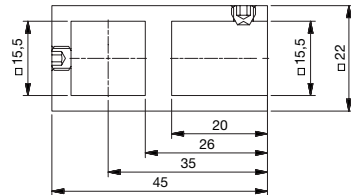

**Black
EDITION**

Art.-Nr. Article no.	Oberfläche Finish	Artikelbezeichnung Article name	VE/Stück Pu/pieces
8497MSPVD35-T	Schwarz matt Matt black	T-Stück-Verbinder für Stabilisationsstange T-adapter for supporting bar	1/1
8497MSPVD36-T	Schwarz glänzend Gloss black		
8497MS35-T	RAL9005 Schwarz matt RAL9005 Matt black		
8497MS36-T	RAL9005 Schwarz glänzend RAL9005 Gloss black		

für Rohr □ 15 mm | for tube □ 15 mm

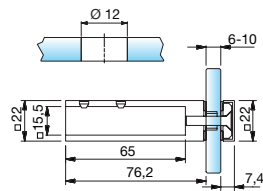

**Black
EDITION**

Art.-Nr. Article no.	Oberfläche Finish	Glasdicke Glass thickness	Artikelbezeichnung Article name	VE/Stück Pu/pieces
8498MSPVD35-G	Schwarz matt Matt black	6-10 mm	Glasanschluss für Stabilisationsstange glass adapter for supporting bar	1/1
8498MSPVD36-G	Schwarz glänzend Gloss black			

für Rohr □ 15 mm | for tube □ 15 mm

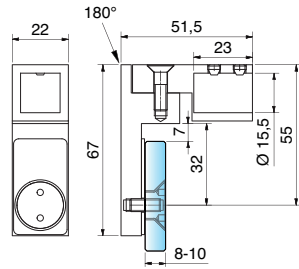

**Black
EDITION**

Art.-Nr. Article no.	Oberfläche Finish	Artikelbezeichnung Article name	VE/Stück Pu/pieces
8494MSPVD35-GF	Schwarz matt Matt black	Glasanschluss flächenbündig, für Stabilisationsstange	1/1
8494MSPVD36-GF	Schwarz glänzend Gloss black	glass adapter flush for supporting bar	

für Rohr □ 15 mm | for tube □ 15 mm

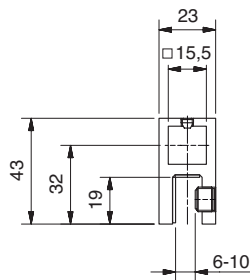

**Black
EDITION**

Art.-Nr. Article no.	Oberfläche Finish	Artikelbezeichnung Article name	VE/Stück Pu/pieces
8494MSPVD35-GT	Schwarz matt Matt black	Glasanschluss, T-Stück senkrecht	1/1
8494MSPVD36-GT	Schwarz glänzend Gloss black	glass adapter, vertical T-pieces	

für Rohr □ 15 mm | for tube □ 15 mm

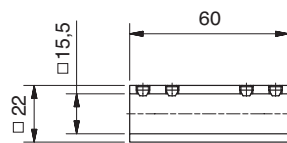

**Black
EDITION**

Art.-Nr. Article no.	Oberfläche Finish	Artikelbezeichnung Article name	VE/Stück Pu/pieces
8494MSPVD35-V180	Schwarz matt Matt black	Rohrverbinder 180°	1/1
8494MSPVD36-V180	Schwarz glänzend Gloss black	tube connector 180°	

für Rohr □ 15 mm | for tube □ 15 mm

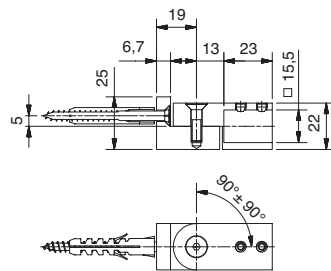

**Black
EDITION**

Art.-Nr. Article no.	Oberfläche Finish	Artikelbezeichnung Article name	VE/Stück Pu/pieces
8494MSPVD35-WV	Schwarz matt Matt black	Wandanschluss verstellbar ± 90°	1/1
8494MSPVD36-WV	Schwarz glänzend Gloss black	wall adapter adjustable ± 90°	

Dichtprofile mit geringem Glaseinstand in schwarz und transparent
 Seal profiles with a reduced glass insertion in black and transparent

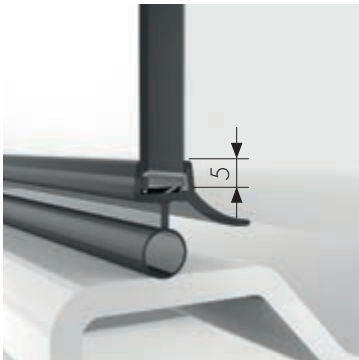

Art.-Nr. | Art.-No.
 8863KU0-8K-2010
 transparent | transparent
 8863KU3-8K-2010
 schwarz | black

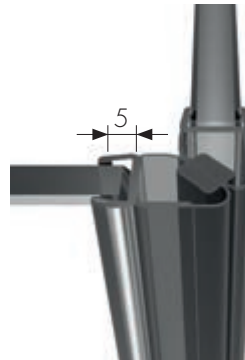

Art.-Nr. | Art.-No.
 8851KU0-8K-2500
 transparent | transparent
 8851KU3-8K-2500
 schwarz | black

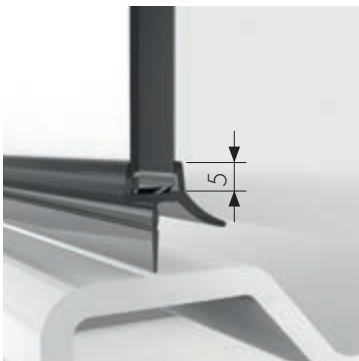

Art.-Nr. | Art.-No.
 8864KU0-8K-2010
 transparent | transparent
 8864KU3-8K-2010
 schwarz | black



Art.-Nr. | Art.-No.
 8864KU0-8K-2010
 transparent | transparent
 8864KU3-8K-2010
 schwarz | black
 mit Schallschutz | with splash guard
 8590AL35-1400

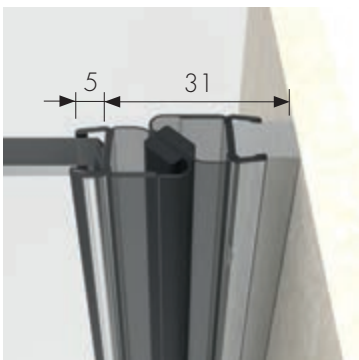

Art.-Nr. | Art.-No.
 8852KU0-8K-2500
 transparent | transparent
 8852KU3-8K-2500
 schwarz | black



Art.-Nr. | Art.-No.
 8852KU0-8K-2500
 transparent | transparent
 8852KU3-8K-2500
 schwarz | black
 Version – Glas-Glas
 version – glass-glass

Schwallschutzprofile Splash guards

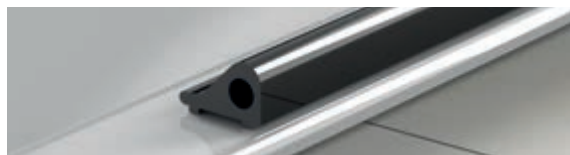

**Black
EDITION**

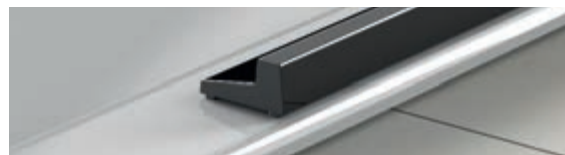

**Black
EDITION**

Art.-Nr. Art.-no.	Artikelbezeichnung Article name
8535AL35-1400	Schwallschutzprofil in einer Länge von 1400 mm
8535AL36-1400	splash guard a length of 1400 mm

Art.-Nr. Art.-no.	Artikelbezeichnung Article name
8590AL35-1400	Schwallschutzprofil in eckiger Version, Länge 1400 mm
8590AL36-1400	splash guard profile square length 1400 mm

Dichtprofile für den unteren Wannanschluss For sealing profiles for shower door/tray

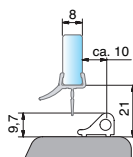

Art.-Nr. Art.-no.	Artikelbezeichnung Article name
8864KU0-8K-2010	für 8 mm Glas in Verbindung mit Schwallschutzprofil (Art.-Nr. 8535E6EV5)
8864KU3-8K-2010	for 8 mm glass in combination with splash guard (Art. no. 8535E6EV5)

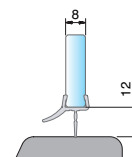

Art.-Nr. Art.-no.	Artikelbezeichnung Article name
8864KU0-8K-2010	für 8 mm Glas
8864KU3-8K-2010	for 8 mm glass

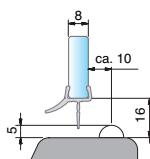

Art.-Nr. Art.-no.	Artikelbezeichnung Article name
8864KU0-8K-2010	für 8 mm Glas in Verbindung mit Acrylhalbrundstab (Art.-Nr. 8538KU5, Radius = 5 mm)
8864KU3-8K-2010	for 8 mm glass in combination with acrylic semi-circular rod (Art. no. 8538KU5, radius = 5 mm)

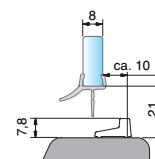

Art.-Nr. Art.-no.	Artikelbezeichnung Article name
8864KU0-8K-2010	für 8 mm Glas in Verbindung mit Schwallschutzprofil
8864KU3-8K-2010	(Art.-Nr. 8590AL35-1400) eckige Version for 8 mm glass in combination with splash guard (Art.No. 8590AL35-1400)

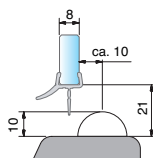

Art.-Nr. Art.-no.	Artikelbezeichnung Article name
8864KU0-8K-2010	für 8 mm Glas in Verbindung mit Acrylhalbrundstab (Art.-Nr. 8539KU5, Radius=10 mm)
8864KU3-8K-2010	for 8 mm glass in combination with acrylic semi-circular rod (Art. no. 8539KU5, radius = 10 mm)

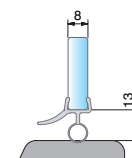

Art.-Nr. Art.-no.	Artikelbezeichnung Article name
8863KU0-8K-2010	für 8 mm Glas
8863KU3-8K-2010	for 8 mm glass

Dichtprofile für Glas-Glas 90° Sealing profiles for glass-glass 90°

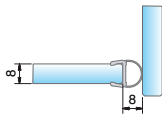

Art.-Nr. Art.-no.	Artikelbezeichnung Article name
8861KU0-8K-2500	für 8 mm Glas für ein ein- und beidseitig zu öffnendes Duschtürband for 8 mm glass for a one sided opening shower hinge or pendelum shower hinge
8861KU3-8K-2500	

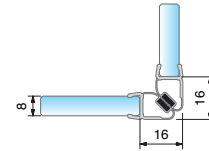
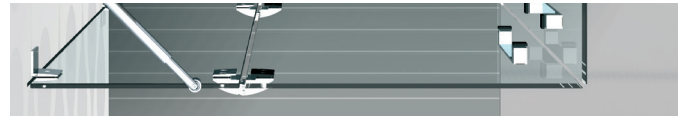

Art.-Nr. Art.-no.	Artikelbezeichnung Article name
8851KU0-8K-2500	für 8 mm Glas für ein einseitig nach außen hin öffnendes Duschtürband for 8 mm glass for a one sided opening shower hinge or pendelum shower hinge
8851KU3-8K-2500	

Dichtprofile für Glas-Glas 135° Sealing profiles for glass-glass 135°

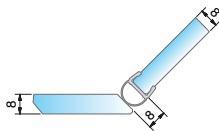

Art.-Nr. Art.-no.	Artikelbezeichnung Article name
8861KU0-8K-2500	für 8 mm Glas für ein beidseitig zu öffnendes Duschtürband for 8 mm glass for a one sided opening shower hinge or pendelum shower hinge
8861KU3-8K-2500	

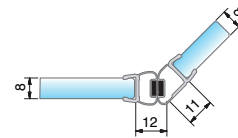

Art.-Nr. Art.-no.	Artikelbezeichnung Article name
8875KU0-8K-2500	für 8 mm Glas für ein ein- und beidseitig zu öffnendes Duschtürband for 8 mm glass for a one sided opening shower hinge or pendelum shower hinge
8875KU3-8K-2500	

Dichtprofile für Glas-Glas 180° Sealing profiles for glass-glass 180°

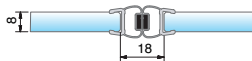

Art.-Nr. Art.-no.	Artikelbezeichnung Article name
8850KU0-8K-2500	für 8 mm Glas für ein beidseitig öffnendes Duschtürband
8850KU3-8K-2500	for 8 mm glass for a pendelum shower hinge

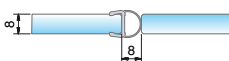

Art.-Nr. Art.-no.	Artikelbezeichnung Article name
8861KU0-8K-2500	für 8 mm Glas für ein beidseitig öffnendes Duschtürband
8861KU3-8K-2500	for 8 mm glass for a pendelum shower hinge

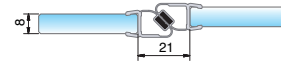

Art.-Nr. Art.-no.	Artikelbezeichnung Article name
8852KU0-8K-2500	für 8 mm Glas für ein einseitig öffnendes Duschtürband
8852KU3-8K-2500	for 8 mm glass for a one sided opening shower hinge

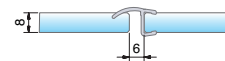

Art.-Nr. Art.-no.	Artikelbezeichnung Article name
8857KU0-8K-2500	für 8 mm Glas für ein einseitig öffnendes Duschtürband
8857KU3-8K-2500	for 8 mm glass for a one sided opening shower hinge

Dichtprofile für den seitlichen Wandanschluss 90°
Sealing profiles for door/wall 90°

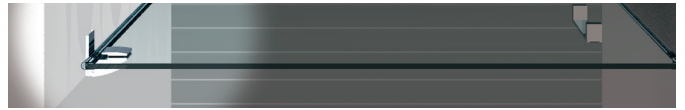
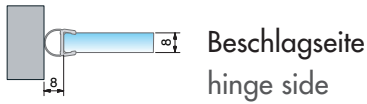

Art.-Nr. Art.-no.	Artikelbezeichnung Article name
8861KU0-8K-2500	für 8 mm Glas als Wanddichtung für ein beidseitig öffnendes Duschtürband
8861KU3-8K-2500	for 8 mm glass as a sealing to the wall for a pendulum shower hinge

Dichtprofile für den seitlichen Wandanschluss 90°
Sealing profiles for door/wall 90°



Art.-Nr. Art.-no.	Artikelbezeichnung Article name
8861KU0-8K-2500	für 8 mm Glas als Wanddichtung für ein beidseitig öffnendes Duschtürband
8861KU3-8K-2500	for 8 mm glass as a sealing to the wall for a pendulum shower hinge

Dichtprofil an Trägerprofil für Türanschlag
Sealing profile for carrier profile for door stop

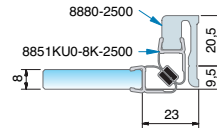
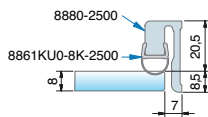

Art.-Nr. Art.-no.	Artikelbezeichnung Article name
8861KU0-8K-2500	für 8 mm Glas Trägerprofil mit Türanschlag
8861KU3-8K-2500	for 8 mm glass carrier profile for door stop

Art.-Nr. Art.-no.	Artikelbezeichnung Article name
8851KU0-8K-2500	für 8 mm Glas Trägerprofil mit Türanschlag
8851KU3-8K-2500	for 8 mm glass carrier profile for door stop

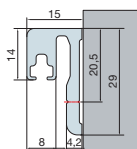

Art.-Nr. Art.-no.	Artikelbezeichnung Article name
8880_*2010	Länge = 2010 mm, Oberflächen siehe Art.-Nr.Endung
8880_*2500	length = 2010 mm, finished see article-no.-end länge = 2500 mm, Oberflächen siehe Art.-Nr.Endung length = 2500 mm, finished see article-no.-end

*Art.-Nr.-Material/Oberfläche: E6/EV1 = Aluminium spezialgebeizt naturfarbig eloxiert; E6/EV5 = Aluminium spezialgebeizt glanzeloxiert; E1/23 = Aluminium geschliffen silberfarbig eloxiert (Edelstahleffekt); KU0 = Kunststoff naturfarbig-opak; KU3 = Kunststoff naturfarbig-opak

*Art.-No.-Material/Oberfläche: E6/EV1 = aluminium special etched anodised natural colour; E6/EV5 = aluminium special etched anodised gloss chrome finish; E0/14 = aluminium white powder coated, RAL 9016; KU0 = plastic natural colour opaque; KU3 = plastic black

Trägerprofil für Dichtprofil Carrier profile for sealing

Bohrungsabstände
Bore gaps

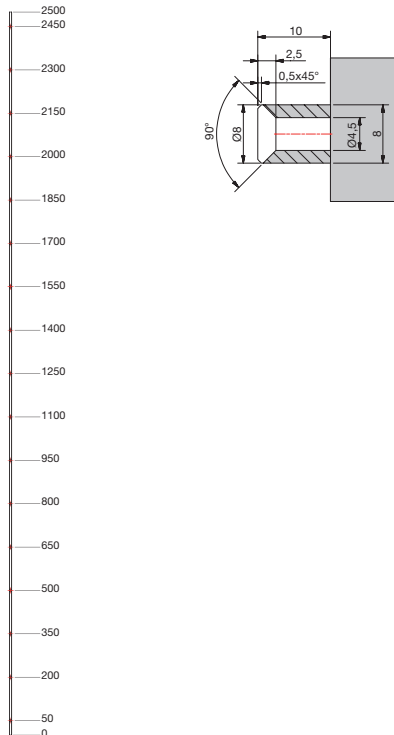

Anwendungen Trägerprofil
Applications profile

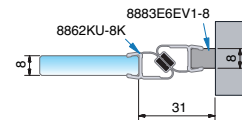

Art.-Nr. Art.-no.	Artikelbezeichnung Article name
8852KU0-8K-2500	für 8 mm Glas, mit Dichtprofil und Trägerprofil 8883E6EV1-8
8852KU3-8K-2500	for 8 mm glass with sealing profile 8852KU0-8K-2500 / 8852KU3-8K-2500 and carrier section 8883E6EV1-8

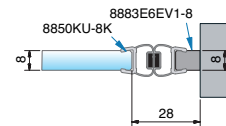

Art.-Nr. Art.-no.	Artikelbezeichnung Article name
8850KU0-8K-2500	für 8 mm Glas, mit Dichtprofil und Trägerprofil 8883E6EV1-8
8850KU3-8K-2500	for 8 mm glass with sealing profile 8850KU0-8K-2500 / 8850KU3-8K-2500 and carrier section 8883E6EV1-8

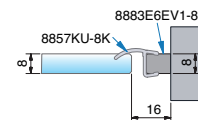

Art.-Nr. Art.-no.	Artikelbezeichnung Article name
8857KU0-8K-2500	für 8 mm Glas, mit Dichtprofil und Trägerprofil 8883E6EV1-8
8857KU3-8K-2500	for 8 mm glass with sealing profile 8857KU0-8K-2500 / 8857KU3-8K-2500 and carrier section 8883E6EV1-8

Allgemeine Geschäftsbedingungen (AGB)

Bestellungen von Produkten aus diesem Katalog führen wir ausschließlich auf der Grundlage und unter Geltung unserer „Allgemeinen Verkaufs- und Lieferbedingungen“ durch. Hiervon abweichende Bedingungen, z.B. allgemeine Einkaufsbedingungen, werden von uns nicht akzeptiert und wir behalten uns ausdrücklich vor, Bestellungen, in denen auf derartige abweichende Bedingungen hingewiesen wird, nicht auszuführen. Unsere „Allgemeinen Verkaufs- und Lieferbedingungen“ können Sie in unseren Geschäftsräumen sowie im Internet auf unserer Homepage www.pauli.de einsehen. Zudem übersenden wir Ihnen gerne ein Exemplar auf Anfrage per Post oder Telefax. Erfüllungsort für sämtliche vertraglichen Verpflichtungen sowie der Gerichtsstand für alle gerichtlichen Auseinandersetzungen ist im kaufmännischen Rechtsverkehr ausschließlich der Sitz unseres Unternehmens in Morsbach.

Schutzrechte

Für zahlreiche Artikel in diesem Katalog sind Patente, Gebrauchs- und Geschmacksmuster angemeldet oder eingetragen. Der vorliegende Katalog ist ausschließlich für den Empfänger bestimmt. Er darf nicht weiterverliehen oder Wettbewerbsunternehmen überlassen werden. Der Herausgeber behält sich das Rückforderungsrecht vor.

Copyright

Nachdrucke – auch auszugsweise – bedürfen unserer ausdrücklichen, schriftlichen Genehmigung.



Pauli + Sohn GmbH

Werk I:

Eisenstraße 2

D-51545 Waldbröl

Telefon: +49 (0) 22 91-92 06-0

Fax: +49 (0) 22 91-92 06-681

Werk II:

Industriestraße 20

D-51597 Morsbach

Telefon: +49 (0) 22 94-98 03-0

Fax: +49 (0) 22 94-98 03-881

www.pauli.de

info@pauli.de

Version 01/2019 Art-Nr. P10-90-20
Alle Bilder, technische Zeichnungen und deren Beschreibungen sind urheberrechtlich geschütztes Eigentum der Pauli + Sohn GmbH. Technische Maßangaben innerhalb des Kataloges sind unverbindlich. Konstruktionsänderungen sind vorbehalten. Bitte beachten Sie unsere Schutzrechte. Für Druckfehler und Irrtümer, die bei der Herstellung unterlaufen sind, ist jede Haftung ausgeschlossen.