

TYP S-01  
TYPE S-01  
Seite | page 354



TYP S-02  
TYPE S-02  
Seite | page 356



TYP S-03  
TYPE S-03  
Seite | page 360



TYP S-04  
TYPE S-04  
Seite | page 366



TYP S-05  
TYPE S-05  
Seite | page 370



TYP S-06  
TYPE S-06  
Seite | page 374



## Vordachsysteme mit Schwertern

canopy systems with swords



**Pauli Service**  
**Pauli Service**



Wir unterstützen Sie!  
We can assist you!

+49 (0) 2291-9206-0  
info@pauli.de



DE



EN

Um unser digitales Anfrageformular zu nutzen, scannen Sie den QR-Code oder gehen Sie auf [www.pauli.de](http://www.pauli.de).  
In order to use our digital inquiry form, scan the QR-code or visit our website at [www.pauli.de](http://www.pauli.de).

\*abZ = german national technical approval





TYP S-01  
TYPE S-01

MADE  
IN  
GERMANY



TYP S-02  
TYPE S-02



TYP S-01  
TYPE S-01

MADE  
IN  
GERMANY



\*abZ = german national technical approval  
Statik = statical calculations available  
BD = rated diagrams available

Dachneigung – nach unten | slope – downward

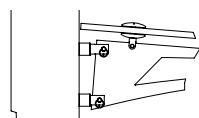

$\alpha$	0°	2°	4°	6°	8°	10°
A	42	47	52	57	62	67
B	42	42	42	42	42	42
C	1003	1010	1017	1024	1031	1038
D	133	140	147	154	161	168
h	150	150	150	150	149	148
w	10	10	10	10	10	10

Dachneigung – nach oben | slope – upward

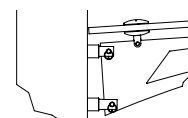

$\alpha$	0°	2°	4°	6°	8°	10°
A	42	42	42	42	42	42
B	42	47	52	57	62	67
C	1003	1001	998	996	994	992
D	133	131	128	126	124	122
h	150	150	150	150	149	148
w	10	10	10	10	10	10



VD TYP S-01 Edelstahl (A2) | TYPE S-01 stainless steel (304)

**2-Achsen-System | 2-axes-system**

Art.-Nr. art.-no.	1706VA-12	1706VA	1706VA-20
	13,52 mm	17,52 mm	21,52 mm



4x 1927VA      2x Schwert | sword      4x Wandhalter | wall support



VD TYP S-01 Edelstahl (A2) | TYPE S-01 stainless steel (304)

**3-Achsen-System | 3-axes-system**

Art.-Nr. art.-no.	1707VA	1707VA-20
	17,52 mm	21,52 mm



6x 1927VA      3x Schwert | sword      6x Wandhalter | wall support

**Abkürzungen | acronym**

- $\alpha$  = Dachneigung | slope
- A = Wandhalterlänge oben | upper wall support length
- B = Wandhalterlänge unten | lower wall support length
- C = Ausladung | outspan
- D = Randabstand | rear distance
- h = Befestigungsabstand | distance between upper and lower support
- w = Glas-Wand-Abstand | glass-wall distance

**Abmessungen | dimensions**

Für 4 Punkthalter | for 4 point fixtures

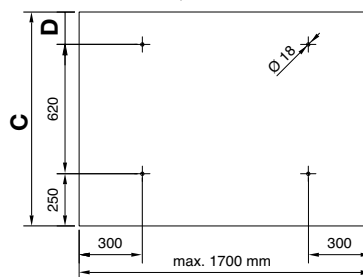

Für 6 Punkthalter | for 6 point fixtures

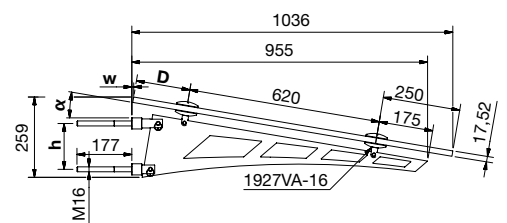
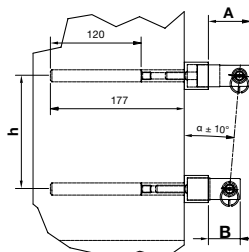
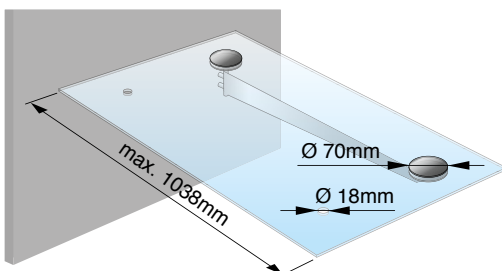
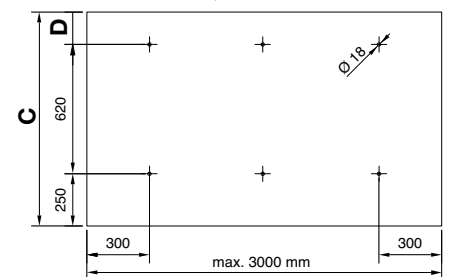



TYP S-02  
TYPE S-02



ZiE = approval on an individual basis  
Statik = statical calculations available  
Statik (yellow button) for Individual Cases



VD TYP S-02 Edelstahl (A2) | TYPE S-02 stainless steel (304)

**2-Achsen-System** | 2-axes-system

Art.-Nr. 1701VA  
art.-no.

 13,52 mm

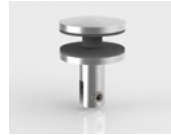

4x Punkthalter  
point fixtures



2x Schwert | sword



4x Wandhalter | wall support



VD TYP S-02 Edelstahl (A2) | TYPE S-02 stainless steel (304)

**3-Achsen-System** | 3-axes-system

Art.-Nr. 1703VA  
art.-no.

 13,52 mm



6x Punkthalter  
point fixtures



3x Schwert | sword



6x Wandhalter | wall support

Abmessungen | dimensions

Wandseite | wall side

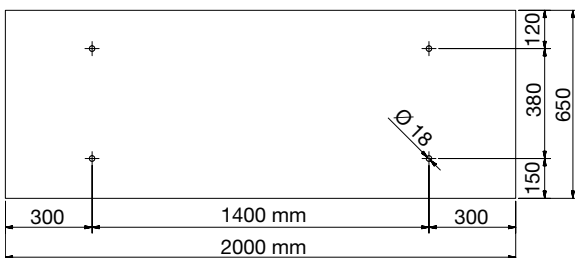

Set 1701VA

Wandseite | wall side

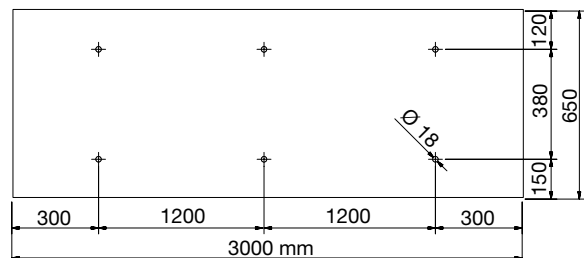

Set 1703VA

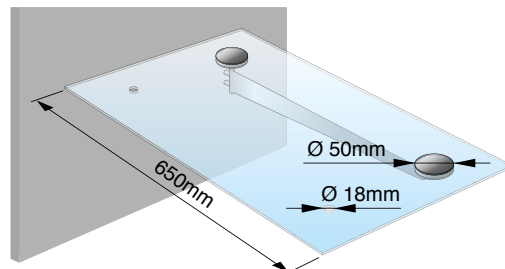
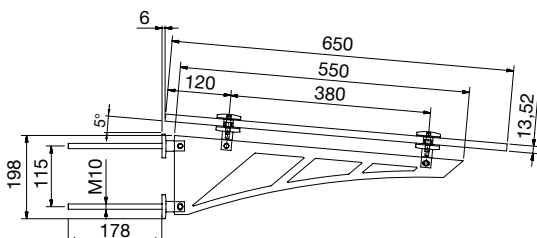





25a

TYP S-03  
TYPE S-03

MADE  
IN  
GERMANY





TYP S-03  
TYPE S-03



Info

Glasdimensionierung | Glass dimensioning 

Einfache und wirtschaftliche Glasdimensionierung gemäß AbZ und typengeprüfter Bemessungsdiagramme. Unterlagen im Katalog zur Bemessung von Vordachsystemen und auf [www.pauli.de](http://www.pauli.de).

Simple and economical glass dimensioning according to the \*AbZ and type-tested design charts. Documents can be found in the catalog about designing canopy systems and on [www.pauli.de](http://www.pauli.de).

\*AbZ = German National Technical Approval  
Statik = Statical calculations available  
BD = Rated diagrams available



Checkliste | Checklist  
[www.pauli.de](http://www.pauli.de)

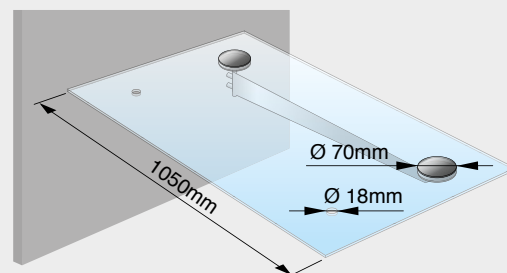

VD TYP S-03 Schmiedeeisen | TYPE S-03 forged steel



2-Achsen-System | 2-Axes-System

Art.-Nr. 1750RAL9005MATT  
Art.-no.

 13,52 mm



4x 1927RAL9005MATT-12



2x Schwert | Sword

Info

Abmessungen | Dimensions

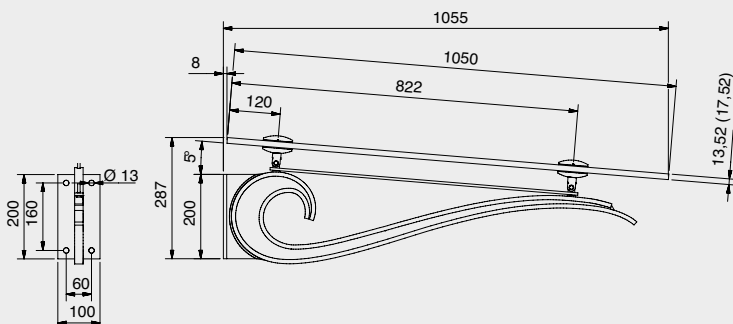

Wandseite | Wall side

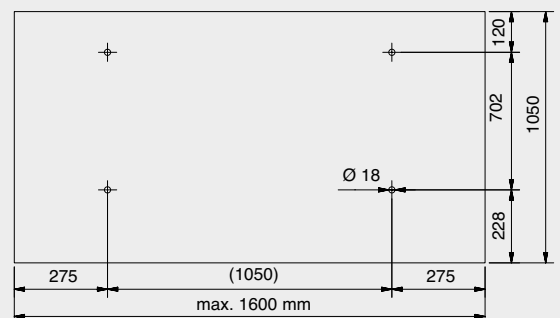

# Vordachsysteme nach DIN 18008

canopies according to DIN 18008





Unsere Vordächer nach DIN 18008 können ohne weitere Nachweise verwendet werden.

Bei uns erhalten Sie direkt die erforderliche Statik für Konstruktion und Glas.

Die DIN 18008 hat die „Technischen Regeln für die Verwendung von linienförmigen Verglasungen“ abgelöst. Die Bemessungsregeln nach der DIN bringen eine Reihe von Veränderungen mit sich. Dies betrifft unter anderem die Dimensionierung von Scheiben. Neu in der DIN 18008 ist eine Bemessung auf Basis der Bruchmechanik mit dem Konzept von Teilsicherheitsfaktoren.

Inhalte der DIN 18008:

- Teil 1: Begriffe und allgemeine Grundlagen
- Teil 2: behandelt linienförmig gelagerte Verglasungen
- Teil 3: behandelt punktförmig gelagerte Verglasungen
- Teil 4: erläutert die Zusatzanforderungen an absturzsichernde Verglasungen
- Teil 5: erklärt die Zusatzanforderungen an begehbare Verglasungen

our canopies according to DIN 18008 can be used without any further verification.

You will receive the required static calculations for the hardware and glass directly from us.

The DIN 18008 supersedes the "building Code for the use of linear glazing". The design rules according to the DIN brings a series of changes. This relates to the dimensions of glass panels. New in DIN 18008 is an assessment based on the fracture mechanics and with the concept of partial safety factors.

Contents of DIN 18008:

- part 1: Terms and general basics
- part 2: Addresses linearly supported glazing
- part 3: Addresses point fixture supported glazing
- part 4: Describes the additional requirements for crash-proof glazing
- part 5: Explains the additional requirements for walk-on glazing



**Pauli Service**  
Pauli Service



Wir unterstützen Sie!  
We can assist you!

+49 (0) 2291-9206-0  
info@pauli.de



DE



EN

Um unser digitales Anfrageformular zu nutzen, scannen Sie den QR-Code oder gehen Sie auf [www.pauli.de](http://www.pauli.de).  
In order to use our digital inquiry form, scan the QR-code or visit our website at [www.pauli.de](http://www.pauli.de).



TYP S-04  
TYPE S-04

MADE  
IN  
GERMANY

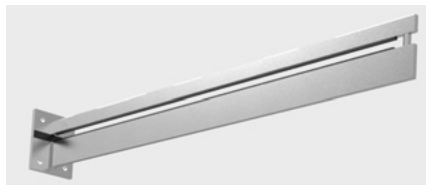

TYP S-05  
TYPE S-05





TYP S-04  
 TYP S-04



Statik = statical calculations available  
 VSG für FG = LSG with float glass



VD TYP S-04 Edelstahl (A2) | TYPE S-04 stainless steel (304)

**2-Achsen-System** | 2-axes-system

Art.-Nr. 1715VA  
art.-no.



17,52 mm

max. 1800 x 1200 mm



2x Kragarm | cantilever



VD TYP S-04 Edelstahl (A2) | TYPE S-04 stainless steel (304)

**3-Achsen-System** | 3-axes-system

Art.-Nr. 1714VA  
art.-no.



17,52 mm

max. 3000 x 1200 mm



3x Kragarm | cantilever



VD TYP S-04 Edelstahl (A2) | TYPE S-04 stainless steel (304)

**4-Achsen-System** | 4-axes-system

Art.-Nr. 1716VA  
art.-no.



17,52 mm

max. 4200 x 1200 mm



4x Kragarm | cantilever

Abmessungen | dimensions

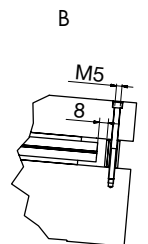
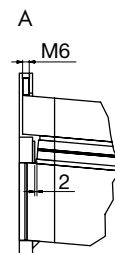
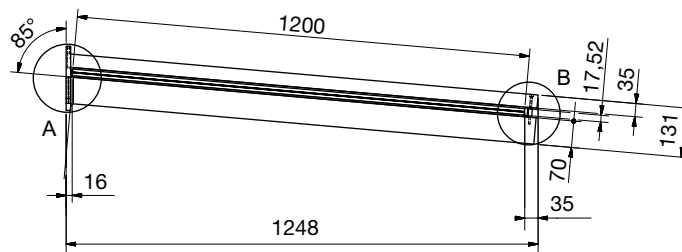
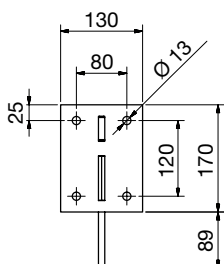

TYP S-04  
TYP S-04



1. Ausleger mit dem für den Befestigungsuntergrund entsprechenden Befestigungsmaterial an der Wand anschrauben.

1. Mount the cantilever to the wall with the appropriate fastener material.



2. Glasscheibe auf die Ausleger auflegen und ausrichten.

Achtung: Glasüberstand am linken bzw. rechten Ausleger muss gleich sein. So kann eine gleichmäßige Belastung der Ausleger gewährleistet werden.

2. Rest and align the glass on the cantilever arm.

Caution: The glass overhang to the left and right must be equal to ensure a uniform load on the cantilevers.



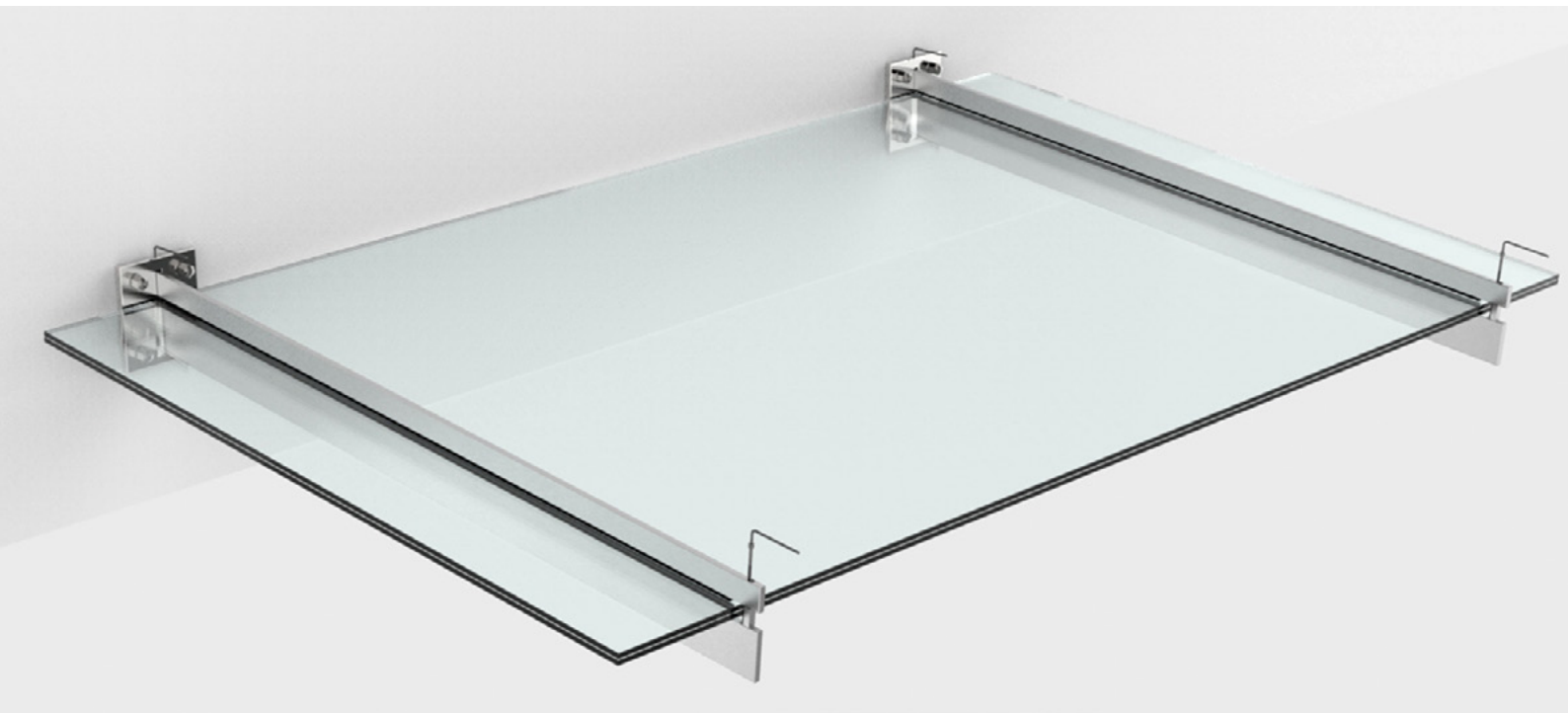

3. Obere Abdeckleiste auflegen und verschrauben.

3. Insert upper clamp bracket and secure it with the provided screws lightly.



4. Die Befestigungsschrauben so weit hineinschrauben, bis es zu einem Kontakt zwischen oberer Deckleiste und Glasscheibe kommt. Im weiteren Verlauf die Schrauben nur noch so weit anziehen, dass die obere Deckleiste sich in ihrer Form (Bogen im mittleren Bereich) nicht verbiegt. Empfehlung: Schrauben abwechselnd anziehen.

4. Insert and turn the screws until there is slight contact of the glass panel and the clamping bracket. Tighten the screws slowly so that the contact along the entire clamp bracket is ensured and does not bow in the middle. Recommendation: tighten the screws alternately.





TYP S-05  
TYP S-05



Statik = statical calculations available  
VSG für FG = LSG with float glass



VD TYP S-05 Edelstahl (A2) | TYPE S-05 stainless steel (304)

**2-Achsen-System** | 2-axes-system

Art.-Nr. art.-no.	1765VA	
	16,76 mm	max. 1500 x 900 mm



2x Kragarm | cantilever

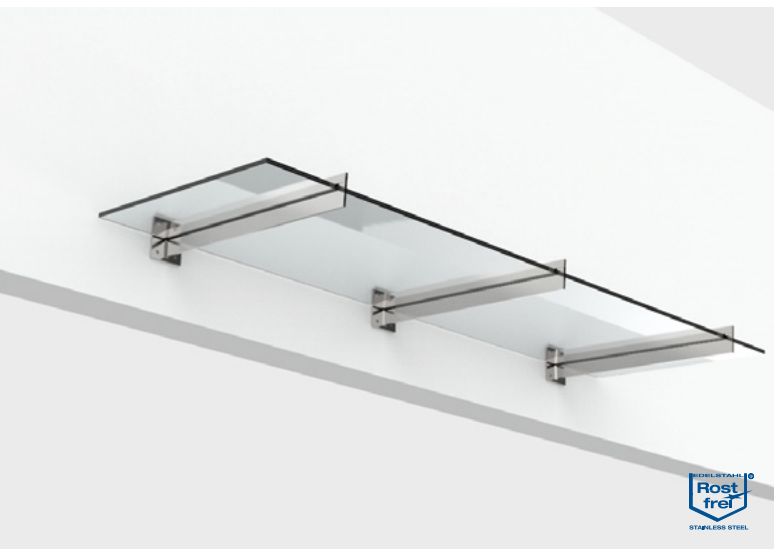

VD TYP S-05 Edelstahl (A2) | TYPE S-05 stainless steel (304)

**3-Achsen-System** | 3-axes-system

Art.-Nr. art.-no.	1764VA	
	16,76 mm	max. 2590 x 900 mm



3x Kragarm | cantilever

Im Pauli+Sohn-Sortiment zeichnen sich 1765VA und 1764VA durch eine kleinere Ausladung aus. Wie bei der größeren Variante S-04 ist die Verwendung von VSG aus Float möglich. Im Einzelfall bietet Pauli + Sohn eine pulverbeschichtete Variante, die eine höhere Farbvielfalt (RAL-Beschichtung) zulässt.

In the Pauli + Sohn range, the 1765VA and 1764VA are distinguished by their a smaller outspan. As with the larger variant S-04, it is possible to use LSG made of float glass. In individual cases, Pauli + Sohn offers a powder-coated variant, which provides a greater color variety (RAL coating).

**Abmessungen** | dimensions

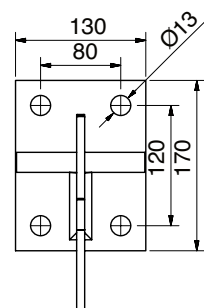
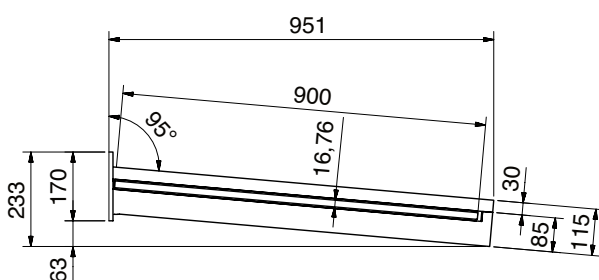





TYP S-06  
TYP S-06

MADE  
IN  
GERMANY







TYP S-06  
TYP S-06



Statik = statical calculations available  
VSG für FG = LSG with float glass



VD TYP S-06 Edelstahl (A2) | TYPE S-06 stainless steel (304)

**2-Achsen-System** | 2-axes-system

Art.-Nr. art.-no.	1710VA	
	16,76/17,52 mm	max. 1800 x 1190 mm



2x Kragarm | cantilever



VD TYP S-06 Edelstahl (A2) | TYPE S-06 stainless steel (304)

**3-Achsen-System** | 3-axes-system

Art.-Nr. art.-no.	1711VA	
	16,76/17,52 mm	max. 3000 x 1190 mm



3x Kragarm | cantilever

**Abmessungen** | dimensions

